



Operator's Manual

LeCROY DIGITAL OSCILLOSCOPES
SERIES 9304, 9310 & 9314



LeCroy

Innovators in Instrumentation

OPERATOR'S MANUAL

**LeCROY DIGITAL OSCILLOSCOPES
SERIES 9304, 9310 & 9314**

Revision B – July 1993

LeCroy

Corporate Headquarters

700 Chestnut Ridge Road
Chestnut Ridge, NY 10977-6499
Tel: (914) 425-2000, TWX: 710-577-2832

European Headquarters

2, rue du Pré-de-la-Fontaine
P.O. Box 341
1217 Meyrin 1/Geneva, Switzerland
Tel.: (022) 719 21 11, Telex: 419 058

Copyright© July 1993, LeCroy. All rights reserved. Information in this publication supersedes all earlier versions. Specifications subject to change.

TABLE OF CONTENTS

INTRODUCTION

1	Key Features	
2	General Information	
	Initial Inspection	2-1
	Warranty	2-1
	Product Assistance	2-1
	Maintenance Agreements	2-2
	Document Discrepancies	2-2
	Service Procedure	2-2
	Return Procedure	2-2
3	Instrument Architecture	
	Architecture	3-1
	ADCs and Memories	3-2
	Trigger	3-2
	Automatic Calibration	3-3
	Display	3-3
	Manual/Remote Control	3-3
4	Installation	
	Operating Environment	4-1
	Power Requirements	4-1
	Safety Information	4-1
	Power On	4-2
5	Front-panel Overview	
6	Control of the Oscilloscope	
	Active Buttons	6-1
	Switching between Menus	6-1
	Performing Actions	6-1
	Setting Menu Options	6-2
	General Instrument Reset	6-3

TABLE OF CONTENTS

DISPLAY

7 Display Overview

Real Time Clock Field (1)	7-1
Displayed Trace Field (2)	7-1
Trigger Level Field (3)	7-1
Acquisition Summary Field (4)	7-1
Trigger Delay Field (5)	7-2
Trigger Configuration Field (6)	7-2
Time and Frequency Field (7)	7-2
Trigger Status Field (8)	7-2
Grid (9)	7-3
Menu Field (10)	7-3
Message Field (11)	7-3

TIMEBASE + TRIGGER

8 Timebase + Trigger Capabilities

Timebase Capabilities	8-1
Trigger Capabilities	8-5
EDGE Trigger	8-5

9 Timebase + Trigger Direct Controls

STOP	9-1
AUTO	9-1
NORM	9-2
SNGL	9-2
AUTO SETUP	9-2
DELAY	9-3
ZERO	9-3
TIME/DIV	9-3
LEVEL	9-3
TIMEBASE SETUP	9-3
TRIGGER SETUP	9-3

TABLE OF CONTENTS

10	Timebase Setup	
	Timebase Setup Menu	10-1
	More on Sequence	10-2
	External Clock	10-4
11	Trigger Setup	
	How the Trigger Modes Overlap	11-1
	Choosing the Trigger Mode	11-1
	Trigger Setup Menu	11-1
	EDGE Trigger	11-2
	SMART Trigger	11-4
	GLITCH Trigger	11-5
	Interval Trigger	11-7
	TV Trigger	11-9
	State Qualified Trigger	11-12
	Edge Qualified Trigger	11-14
	Dropout Trigger	11-16
	Symbols	11-18

CHANNELS

12	Channels Direct Controls	
	2-Channel Oscilloscopes	
	Trace ON/OFF	12-1
	Offset	12-1
	Find	12-1
	Volts/Div	12-1
	VAR	12-1
	Coupling	12-2
	4-Channel Oscilloscopes	
	Trace ON/OFF	12-3
	Select Channel	12-3
	Offset	12-3
	Find	12-3
	Volts/Div	12-4
	VAR	12-4
	Coupling	12-4

TABLE OF CONTENTS

13 Coupling

Coupling Menu	13-1
More on Coupling	13-2
Probes	13-2

ZOOM + MATH

14 Zoom + Math Capabilities

Zoom	14-1
Waveform Mathematics	14-2

15 Zoom + Math Direct Controls

Trace ON/OFF	15-1
Select Trace	15-1
↔ Position	15-1
↕ Position	15-1
↔ Zoom	15-1
↕ Zoom	15-2
Reset	15-2
Math Setup	15-2

16 Math Setup

How to Use Math	16-1
Standard and Optional Processing Packages	16-1
Math Setup Menu	16-2
Setup Menu for Zoom	16-3
Setup Menu for Arithmetic	16-4
Setup Menu for Average	16-5
Setup Menu for Enhanced Resolution	16-7
Setup Menu for Extrema	16-8
Setup Menu for FFT	16-10
Setup Menu for FFT Average	16-11
Setup Menu for Functions	16-12
Setup Menu for Rescale	16-14

MENU CONTROLS

17	Menu Buttons & Knobs	
	Menu Buttons	17-1
	Menu Knobs	17-1
	DISPLAY	17-2
	UTILITIES	17-2
	WAVEFORM STORE	17-2
	WAVEFORM RECALL	17-2
	CURSORS/MEASURE	17-2
	PANEL SETUPS	17-2
	SCREEN DUMP	17-2
	CLEAR SWEEPS	17-2
	General Instrument Reset	17-3
18	Display	
	Standard Display vs XY Display	18-1
	Persistence Display	18-2
	Screen Presentation	18-3
	Standard Display	18-5
	XY Display	18-6
19	Utilities	
	Utilities Main Menu	19-1
	Hardcopy Setup Menu	19-2
	Internal Printer Setup Menu	19-3
	Time/Date Menu	19-4
	GPIB & RS232 Menu	19-5
	RS-232-C Connector	19-6
	Memory Card Utilities Menu	19-7
	Memory Card & Floppy Disk Structure	19-8
	Floppy Disk Utilities Menu	19-10
	Copy Files Menu	19-12
	Special Modes Menu	19-14
	CAL BNC Out Menu	19-15
20	Waveform Store	
	Waveform Store Menu	20-1
21	Waveform Recall	
	Recall Waveform from Memories Menu	21-1
	Recall Waveform from Card or Floppy Menu	21-2

TABLE OF CONTENTS

22	Cursors/Measure	
	Cursors in Standard Display	22-1
	Cursors in Persistence Display	22-1
	Cursors in XY Display	22-1
	Automatic Measurements	22-3
	Pass/Fail	22-3
	Parameter Information & Warning Symbols	22-5
	Cursors Menu	22-6
	Parameters Menu	22-8
	Standard Voltage Parameters	22-9
	Standard Time Parameters	22-10
	Custom Parameters	22-11
	Adding/Deleting Custom Parameters	22-12
	Pass/Fail Testing	22-13
	Pass/Fail Menu	22-14
	Change Test on Parameters	22-15
	Change Limits for Test on Parameters	22-16
	Change Test on Mask	22-17
	Generate Mask from Waveform	22-18
	Recall Mask from Card or Disk	22-19
	Set Pass/Fail Actions	22-20
23	Panel Setups	
	Panel Setups Menu	23-1
	Recall Setup Menu	23-2
	Recall Setup from Card or Disk	23-3
24	Show Status	
	Acquisition Summary	24-1
	System Summary	24-2
	Text & Times Summary	24-3
	Waveform Summary	24-4

TABLE OF CONTENTS

Appendix A Specifications

Appendix B Enhanced Resolution

Appendix C Fast Fourier Transform (FFT)

Appendix D Parameter Measurement Methods

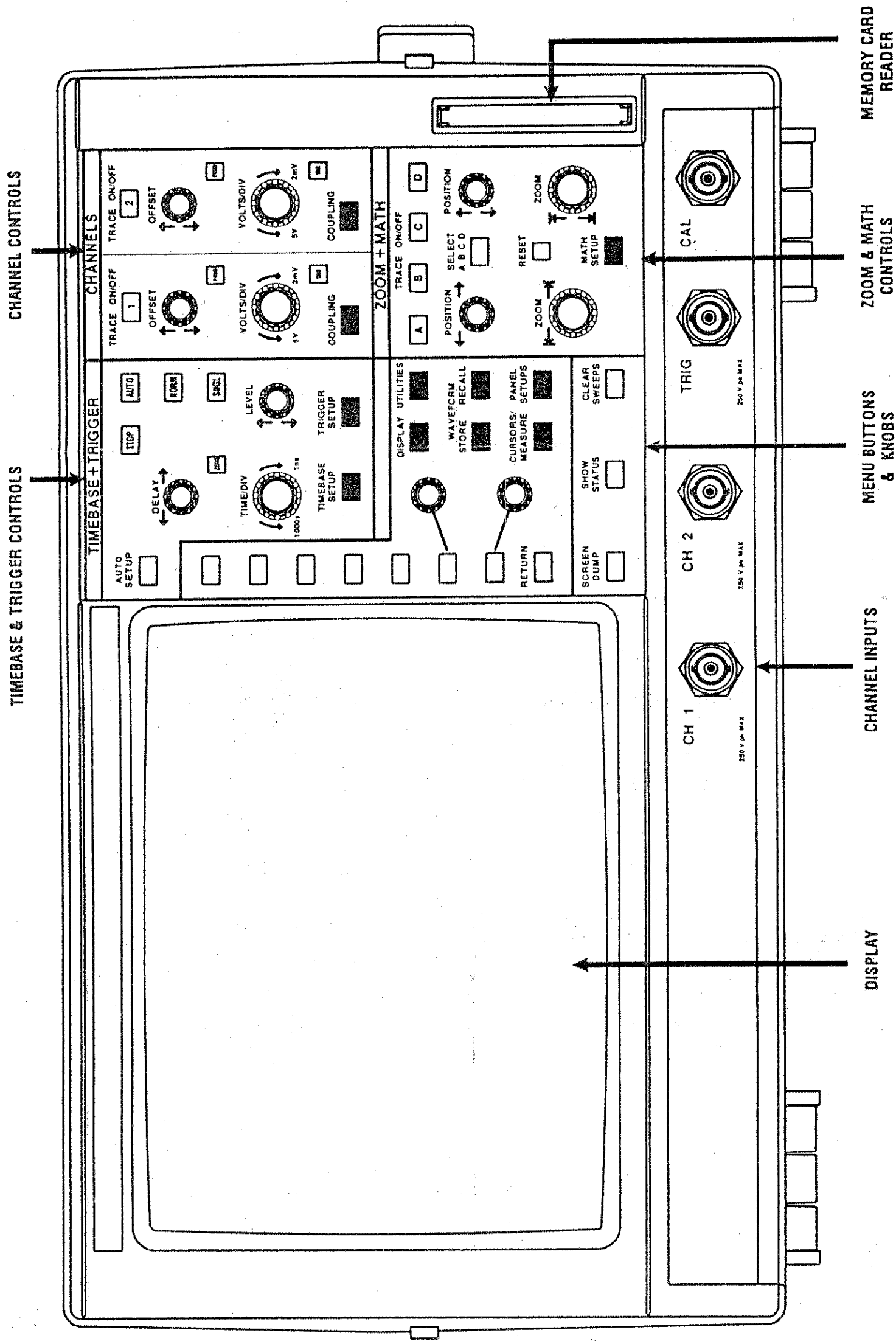

FIGURE A : 2-CHANNEL FRONT-PANEL

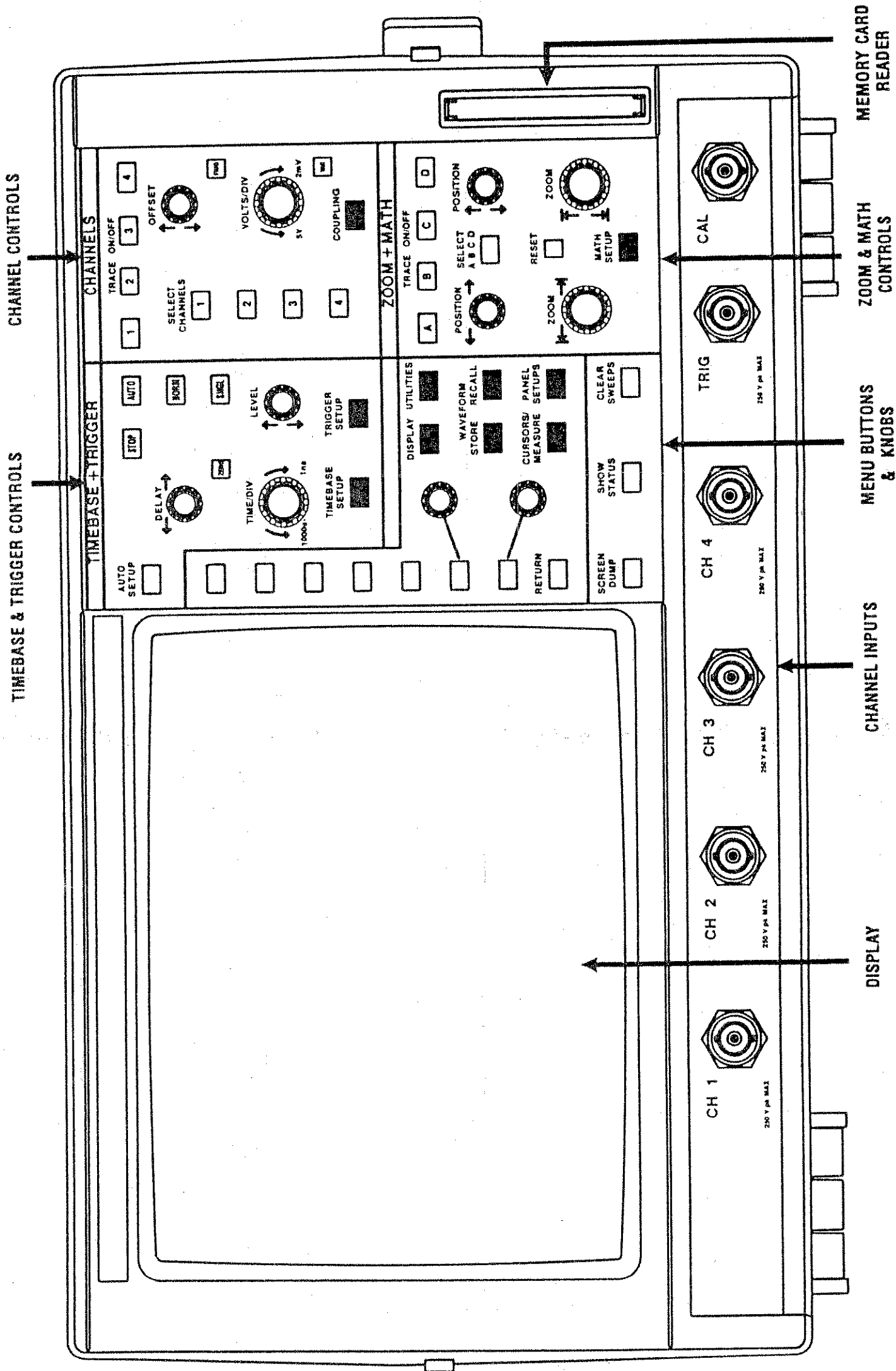

FIGURE B : 4-CHANNEL FRONT-PANEL

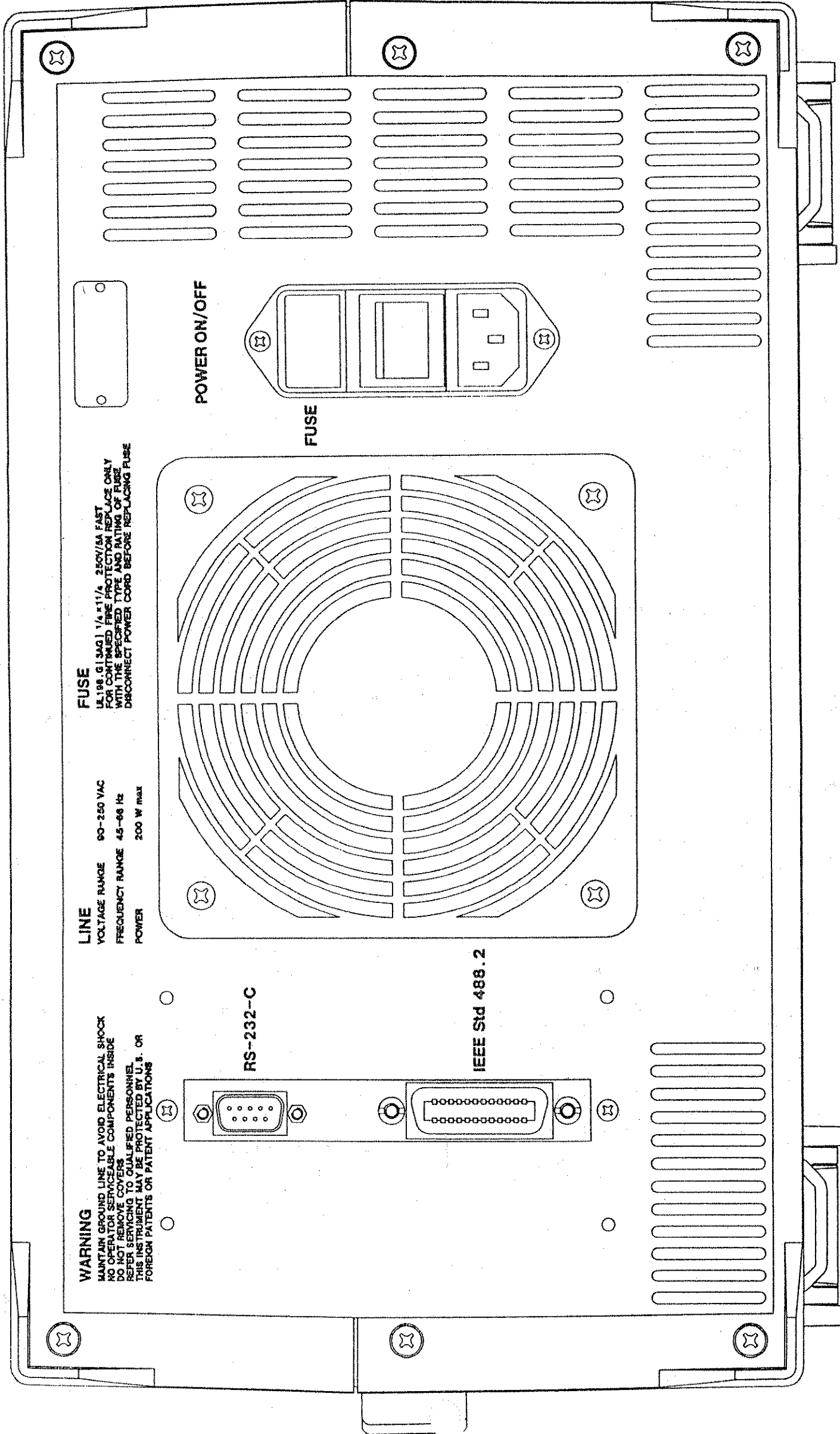

FIGURE C : REAR PANEL

1 Key Features

The LeCroy 9304, 9310 and 9314 series digital oscilloscopes provide a set of powerful features for a wide range of applications. Not only do they allow two- or four-channel simultaneous, high speed single-shot capture, but their extensive capabilities and 10 gigasamples/s repetitive sampling make them invaluable as fast, general-purpose oscilloscopes as well.

The oscilloscopes' key features include:

- 300 MHz bandwidth (175 MHz for the 9304)
- 100 megasamples/s digitizing rate for transient signals
- 10 gigasamples/s digitizing rate for repetitive signals
- 10K, 50K (M models) or 1M (L models) of acquisition memory per channel
- Advanced triggering capabilities including TV and Glitch trigger
- Automatic waveform measurements
- Automatic Pass/Fail testing
- Ultra fast Memory Card or Floppy Disk storage (option)
- Vertical resolution up to 11 bits
- High-resolution display (810 x 696)
- Modular design allows customization to user's needs
- Built-in printer (option)

INITIAL INSPECTION

It is recommended that the shipment be thoroughly inspected immediately upon delivery to the purchaser. All material in the container should be checked against the enclosed Packing List. LeCroy cannot accept responsibility for shortages in comparison with the Packing List unless notified promptly. If the shipment is damaged in any way, please contact the Customer Service Department or local field office immediately.

WARRANTY

LeCroy warrants its oscilloscope products to operate within specifications under normal use for a period of two years from the date of shipment. Spares, replacement parts and repairs are warranted for 90 days. The instrument's firmware is thoroughly tested and thought to be functional, but is supplied "as is" with no warranty of any kind covering detailed performance. Products not manufactured by LeCroy are covered solely by the warranty of the original equipment manufacturer.

In exercising this warranty, LeCroy will repair or, at its option, replace any product returned to the Customer Service Department or an authorized service facility within the warranty period, provided that the warrantor's examination discloses that the product is defective due to workmanship or materials and that the defect has not been caused by misuse, neglect, accident or abnormal conditions or operation.

The purchaser is responsible for transportation and insurance charges for the return of products to the servicing facility. LeCroy will return all in-warranty products with transportation prepaid.

This warranty is in lieu of all other warranties, expressed or implied, including but not limited to any implied warranty of merchantability, fitness, or adequacy for any particular purpose or use. LeCroy shall not be liable for any special, incidental, or consequential damages, whether in contract or otherwise.

PRODUCT ASSISTANCE

Answers to questions concerning installation, calibration, and use of LeCroy equipment are available from the Customer Service Department, 700 Chestnut Ridge Road, Chestnut Ridge, New York 10977-6499, U.S.A., tel. (914)578-6061, and 2, rue du Pré-de-la-Fontaine, 1217 Meyrin 1, Geneva, Switzerland, tel. (41)22/719 21 11, or your local field engineering office.

INTRODUCTION

MAINTENANCE AGREEMENTS

LeCroy offers a selection of customer support services. Maintenance agreements provide extended warranty and allow the customer to budget maintenance costs after the initial two year warranty has expired. Other services such as installation, training, enhancements and on-site repair are available through specific Supplemental Support Agreements.

DOCUMENTATION DISCREPANCIES

LeCroy is committed to providing state-of-the-art instrumentation and is continually refining and improving the performance of its products. While physical modifications can be implemented quite rapidly, the corrected documentation frequently requires more time to produce. Consequently, this manual may not agree in every detail with the accompanying product. There may be small discrepancies in the values of components for the purposes of pulse shape, timing, offset, etc., and, occasionally, minor logic changes. Where any such inconsistencies exist, please be assured that the unit is correct and incorporates the most up-to-date circuitry. In a similar way the firmware may undergo revision when the instrument is serviced. Should this be the case, manual updates will be made available as necessary.

SERVICE PROCEDURE

Products requiring maintenance should be returned to the Customer Service Department or authorized service facility. LeCroy will repair or replace any product under warranty at no charge. The customer is responsible for transportation charges to the factory. All in-warranty products will be returned to the customer with transportation prepaid.

For all LeCroy products in need of repair after the warranty period, the customer must provide a Purchase Order Number before repairs can be initiated. The customer will be billed for parts and labor for the repair, as well as for shipping.

RETURN PROCEDURE

To determine your nearest authorized service facility, contact the Customer Service Department or your field office. All products returned for repair should be identified by the model and serial numbers and include a description of the defect or failure, name and phone number of the user, and, in the case of products returned to the factory, a Return Authorization Number (RAN). The RAN may be obtained by contacting the Customer Service Department in New York, tel. (914)578-6061, in Geneva, tel. (41)22/719 21 11, or your nearest sales office.

Return shipments should be made prepaid. LeCroy will not accept C.O.D. or Collect Return Shipments. Air-freight is generally recommended. Wherever possible, the original shipping carton should be used. If a substitute carton is used, it should be rigid and be packed such that the product is surrounded with a minimum of four inches of excelsior or similar shock-absorbing material. In addressing the shipment, it is important that the Return Authorization Number be displayed on the outside of the container to ensure its prompt routing to the proper department within LeCroy.

3 Instrument Architecture

ARCHITECTURE

The instrument features 100 Megasample/s 8-bit Flash ADCs for each channel. Waveform acquisition memories consist of 10K data points per channel – on Models M and L respectively 50K and 1M. Four memories are available for temporary storage and four additional memories are available for waveform zooming and processing. The central processor is a Motorola 68020 microprocessor which performs computations and controls the oscilloscope's operation.

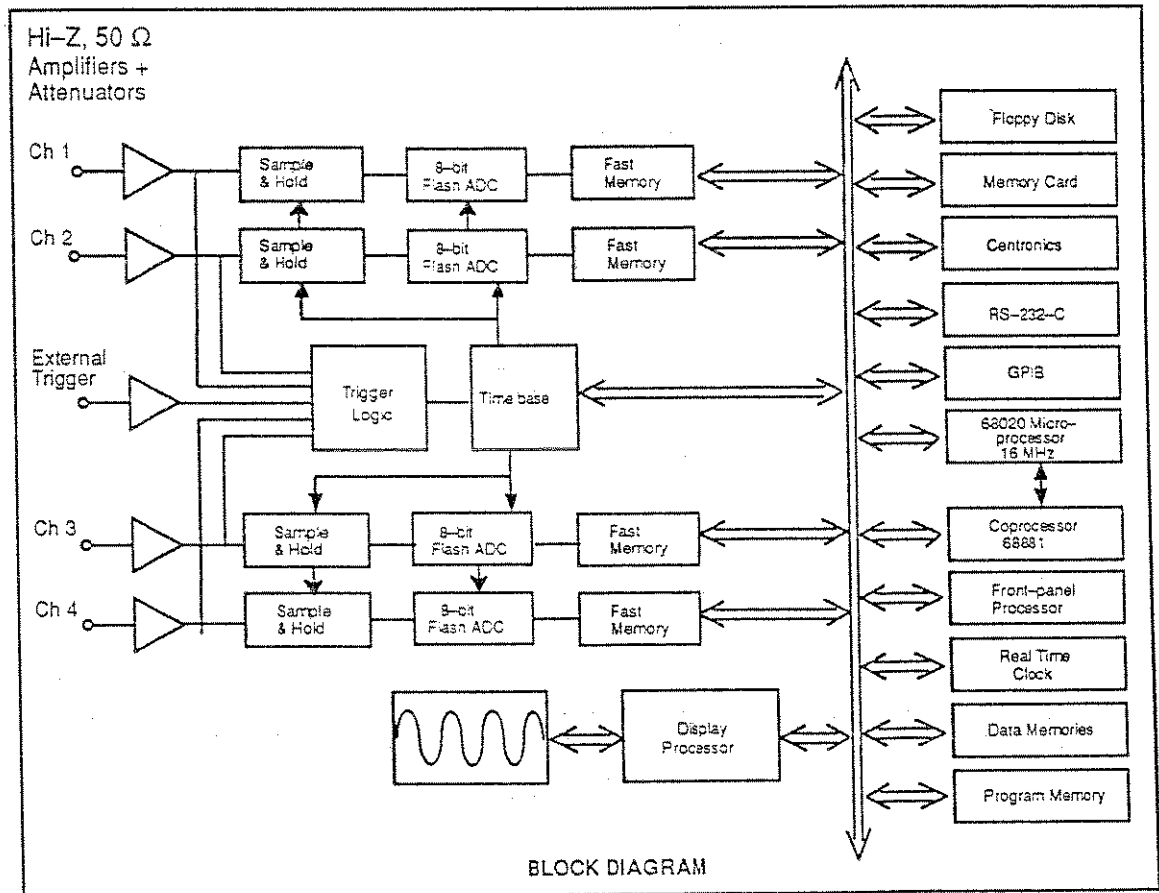

All front-panel knobs and buttons are constantly monitored by the front-panel processor, and front-panel setups are rapidly reconfigured via the unit's internal 16-bit bus. Data are quickly processed according to the selected front-panel setups, and are transferred to the display memory for direct waveform display or stored in the reference memories.

The 68020 controls the unit's GPIB (IEEE-488) remote control port, as well as the RS-232-C port which is used to directly interface the oscilloscope to a digital plotter, printer, remote terminal or other low-speed device.

ADCs AND MEMORIES

Each of the oscilloscope's identical input channels is equipped with a 100 megasample/second, 8-bit ADC. This multiple ADC architecture ensures absolute amplitude and phase correlation, maximum ADC performance for both single- and multi-channel acquisition modes, large record lengths and excellent time resolution.

Acquisition memories of up to 1M simplify transient capture by providing long waveform records that capture waveforms even when trigger timing or signal speed is uncertain. In addition, a special expansion facility magnifies waveforms by up to 20000 times the selected time-base speed.

Repetitive signals can be acquired and stored at a Random Interleaved Sampling (RIS) rate of 10 gigasamples/second. RIS is a high-precision digitizing technique that enables measurement of repetitive signals to the instrument's full bandwidth, with an effective sampling interval of 100 ps and measurement resolution of 10 ps. (See Chapter 8, Timebase + Trigger Capabilities).

TRIGGER

The digitally-controlled trigger system offers an extensive range of trigger capabilities. Front-panel and menu controls allow selection of the appropriate trigger function for the signal.

In the standard trigger mode the front-panel controls are used to select and set parameters such as pre- and post-trigger recording, sequence and roll modes, in addition to the Auto, Normal and Single modes. The trigger source can be any of the input channels, line or external. The coupling is selected from AC, LF REJECT, HF REJECT, HF, and DC, and the slope from positive, negative, and window. (See Chapter 8, Timebase + Trigger Capabilities).

**AUTOMATIC
CALIBRATION**

The oscilloscope has an automatic calibration facility that ensures overall vertical accuracy of $\pm 2\%$ of full scale and a time-base interpolator accuracy of 15 ps RMS for the unit's crystal-controlled time base.

Vertical gain and offset calibration takes place each time the Volts/div is modified. In addition, periodic calibration is performed to ensure long term stability at the current setting.

DISPLAY

The large 12.5 x 17.5 cm (9 inches diagonal) screen displays waveforms with enhanced resolution and serves as an interactive, user-friendly interface via a set of pushbuttons located immediately to the right of the CRT.

The oscilloscope displays up to four waveforms, while simultaneously reporting the parameters controlling signal acquisition. The screen also presents internal status and measurement results, as well as operational, measurement, and waveform analysis menus.

A hard copy of the screen is available via the unit's front-panel screen dump button.

**MANUAL/REMOTE
CONTROL**

The layout of the front-panel and operation will be very familiar to users of analog oscilloscopes. The "analog" feel is emphasized by rapid instrument response and the fact that waveforms are presented instantly on the high-resolution screen.

The oscilloscope has also been designed for remote control operation in automated testing and computer-aided measurement applications. The entire measurement process, including cursor and pulse parameter settings, dynamic modification of front-panel settings, and display organization, can be controlled via the rear-panel GPIB (IEEE-488) and RS-232-C ports.

Four front-panel setups can be stored and recalled either manually or by remote control, thus ensuring rapid front-panel configuration. When the power is switched off, the current front-panel setting is automatically stored for subsequent recall at the next power on.

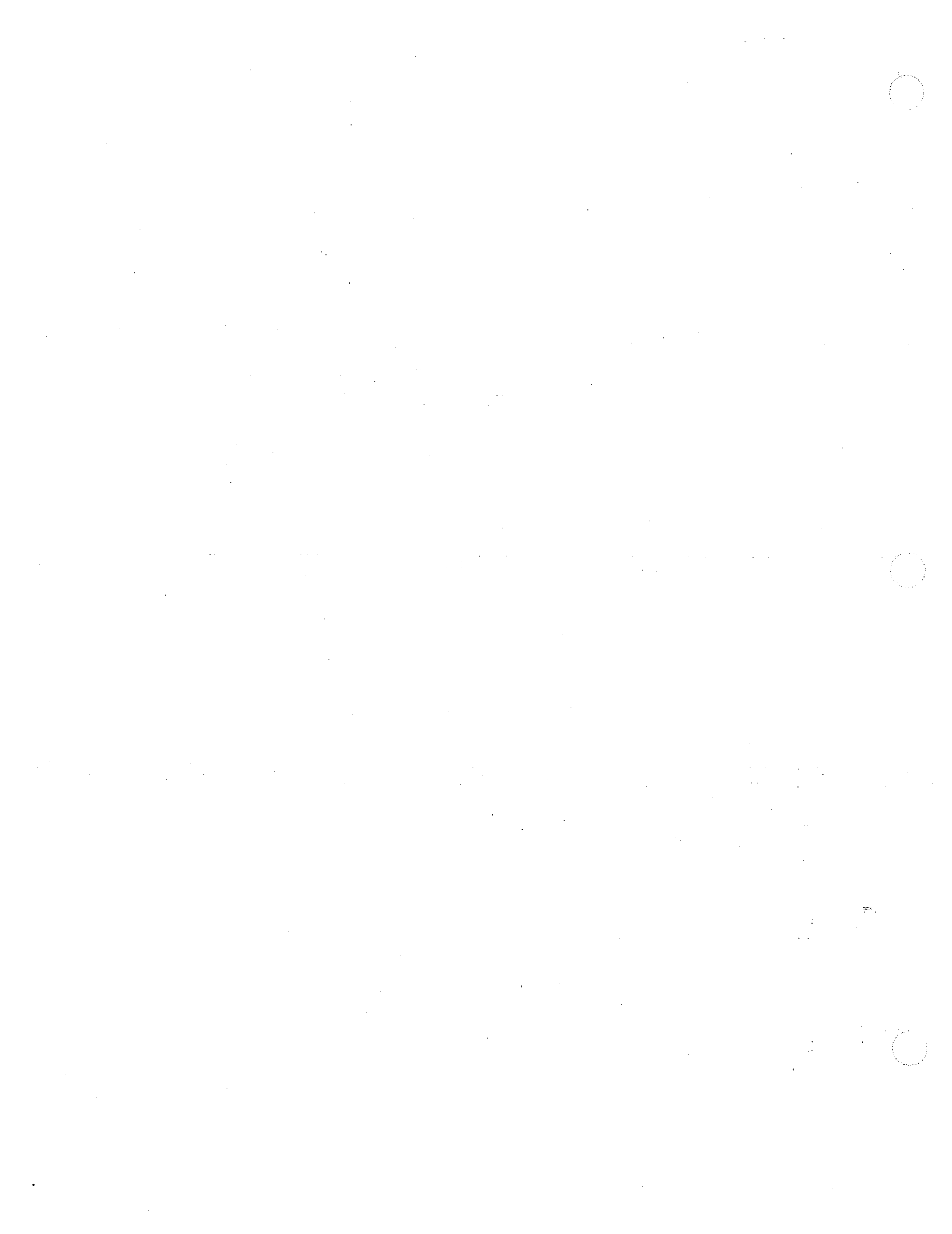

OPERATING ENVIRONMENT

The oscilloscope will operate to its specifications if the environment is maintained within the following parameters:

Temperature 5° to 40° C (41° to 104° F)
Humidity <80%

POWER REQUIREMENTS

The oscilloscope operates from a 115 V (90 to 132 V) or 220 V (180 to 250 V) normal power source at 45 Hz to 66 Hz. No voltage selection is required since the instrument automatically adapts to the line voltage which is present.

The instrument operates at line frequencies up to 440 Hz. However, the leakage current from phase to ground slightly exceeds the safety recommendations for industrial instruments in some countries. This current reaches 4 mA max. at 250 V/400 Hz.

The power supply of the oscilloscope is protected against short circuits and overload by means of two 5A/250 V fuses. The fuses are located above the mains plug.

Remove the power cable before changing or inspecting a fuse. Open the fuse box by inserting a small screwdriver under the plastic cover and prying it open.

SAFETY INFORMATION

The oscilloscope has been designed to operate from a single-phase power source with one of the current-carrying conductors (neutral conductor) at ground (earth) potential. However, operation from power sources in which both current-carrying conductors are live with respect to ground (such as phase-to-phase on a tri-phase system) is also possible, as the oscilloscope is equipped with over-current protection for both mains conductors. None of the current-carrying conductors may exceed 250 V RMS with respect to ground potential. The oscilloscope is provided with a three-wire electrical cord containing a three-terminal polarized plug for mains voltage and safety ground connection. The plug's ground terminal is connected directly to the frame of the unit. For adequate protection against electrical hazard, this plug *must* be inserted into a mating outlet containing a safety ground contact.

The oscilloscope has not been designed to make direct measurements on the human body. Users who connect a LeCroy oscilloscope directly to a person do so at their own risk.

INTRODUCTION

POWER ON

Connect the oscilloscope to the power outlet and switch it on by pressing the power switch located on the rear panel. After the instrument is switched on, auto-calibration is performed and a test of the oscilloscope's ADCs and memories is carried out. The full testing procedure takes approximately 10 seconds, after which time a display will appear on the screen.

See front-panel foldout at the beginning of the manual.

TIMEBASE & TRIGGER CONTROLS allow direct adjustment of Time/Div, Trigger Level and Trigger Delay. The **AUTOSETUP** button automatically adjusts the oscilloscope to acquire and display signals on the input channels.

CHANNEL CONTROLS allow direct adjustment of vertical sensitivity and offset. The **FIND** button automatically adjusts the sensitivity and offset to match the input signal.

The **MEMORY CARD READER** allows fast and convenient storage of waveforms and instrument setups.

ZOOM & MATH CONTROLS allow you to move, define and expand a trace. (The **SELECT ABCD** button is used to select a trace).

MENU BUTTON & KNOBS allow easy control of the most sophisticated tasks.

CHANNEL INPUTS have selectable input impedance of 50Ω or $1M\Omega$ over the entire sensitivity range.

DISPLAY. High-resolution 9-inch screen.

Many of the most commonly used controls can be directly accessed using the labelled pushbuttons and rotary knobs on the front panel. Activating these controls usually causes an immediate visible action. The dark grey buttons of the front panel turn on menus on the right-hand side of the display. These menus allow further control of the acquisition, processing, and display modes of the instrument. The SHOW STATUS button gives access to a series of displays summarizing the status of the acquisition, the instrument, and the waveforms.

The eleven dark grey buttons, together with the SHOW STATUS buttons, all give access to menus which have similar behavior. These are the MENU ENTRY keys.

ACTIVE BUTTONS

Menu buttons which are active have boxes drawn around their accompanying texts on the screen. Other texts are for information only and the corresponding buttons are not used. There are seven menu buttons. The last two buttons also have associated knobs.

SWITCHING BETWEEN MENUS



Printer
Setup

Any time a MENU ENTRY key is pressed, the instrument immediately displays the desired configuration. This menu becomes the new primary menu.

Some of these primary menus have secondary menus under them. The heavy outline of the box associated with the button shows that there is a hidden menu behind it. Pushing the button will cause the appropriate secondary menu to be shown.

Whenever the RETURN button is pressed, the previous primary menu is shown. If the current menu is a primary menu then the menu will be switched off.

When the oscilloscope is put under remote control, the REMOTE ENABLE menu will be shown. It will contain a button "GO TO LOCAL" if this transition is allowed. This is the only manual way to turn the REMOTE ENABLE menu off.

PERFORMING ACTIONS

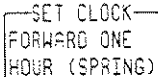

SET CLOCK
FORWARD ONE
HOUR (SPRING)

While most menu buttons modify a selected variable, some perform specific actions. In this case, the text which accompanies the button is written in all capital letters.

In most cases, the effect of changing a value in a menu causes the appearance of the screen to change because the new value is immediately used to change the acquisition settings or the processing, or for the display to be shown.

INTRODUCTION

SETTING MENU OPTIONS

Many options are controllable via the menu buttons and knobs. When setting up a new configuration the buttons should be adjusted, starting at the top to allow for the fact that the menu control for one primary option may be different from that of another primary option.

```
Auto-Store  
OFF  
Wrap Fill
```

Some "single" buttons have one highlighted field among several in their associated texts. Pressing the button advances the highlighted field. If there is a knob associated with the button, it can also be used to navigate among the choices. If only one choice is shown, the button will not do anything.

```
Math Type  
Enh. Res  
Extrema  
FF  
FFTAVG  
Functions
```

There are also "double" buttons with one highlighted field. In this case, pressing the lower button causes the highlight to go forward among the choices whereas pressing the upper button causes the highlight to go backward. The arrow at the side of the button's text shows how the highlight will move. The arrow is missing if the highlight is at the beginning or end of the list of allowed values.

```
For  
1000  
(sweeps)
```

Some button and knob combinations control the value of a continuously adjustable variable. The knob is used to set the value of the variable, while the button may be used to either choose a highlighted field or make a simple change of the value of the variable.

```
holdoff  
153 evts  
OFF Time EVTS
```

```
trigger on  
Line Field  
266 2
```

Other button and knob combinations control the value of several continuously adjustable variables. The knob is used to set the value of the variable which is highlighted, while the button is used to choose which variable is to be highlighted.

```
limit  
+2.7 E+00  
2 digits
```

**GENERAL INSTRUMENT
RESET**

To reset the instrument, simultaneously press the AUTO SETUP button, the top menu-button, and the RETURN button. The instrument will revert to its default power-up settings.

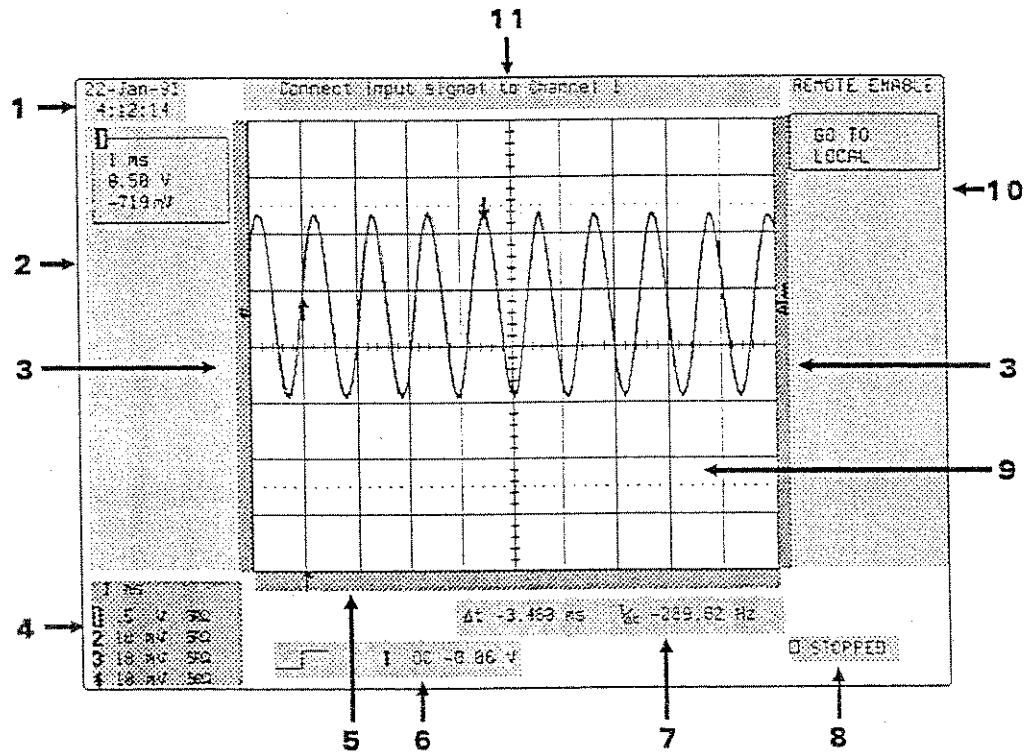

REAL-TIME CLOCK FIELD (1)

Displays the current date and time provided by a battery-backed real-time clock.

DISPLAYED TRACE FIELD (2)

Contains the identity of the displayed trace, its timebase and Volts/div settings, and cursor readings when applicable. Up to four traces can be shown simultaneously.

TRIGGER LEVEL FIELD (3)

Contains the trigger level indicator on both sides of the grid, and the ground indicator for each channel on the right side of the grid.

ACQUISITION SUMMARY FIELD (4)

Contains the common time-base setting and, for each channel, the vertical gain, probe attenuation and coupling. For 4-channel instruments, the currently selected channel is highlighted.

DISPLAY

Note: The displayed trace field shows the acquisition parameters that were set when the trace was captured or processed, whereas the acquisition summary indicates the present setting.

- TRIGGER DELAY FIELD (5)** Indicates the trigger delay (arrow symbol) with respect to the left-hand edge of the grid. The delay can be adjusted from 0 to 10 divisions (pre-trigger) or from 0 to -10000 screen divisions (post-trigger). Pre-trigger delay appears as an upward arrow at the appropriate position in the field. Post-trigger is given as a delay in seconds.
- When the relative-time cursors (two arrow cursors) are active (selected in MEASURE menu), this field displays the time interval between the two cursors. It also displays the frequency corresponding to $1/(\text{time interval})$.
- TRIGGER CONFIGURATION FIELD (6)** Displays the trigger source, slope, level and coupling. When applicable, additional information is given (hold-off by time or by number of events, logic states, etc...). A simple icon gives an overview of the trigger conditions.
- TIME AND FREQUENCY FIELD (7)** When the absolute-time cursor (cross-hair cursor) is active (selected in MEASURE menu), this field displays the time between the cursor and the trigger point.
- TRIGGER STATUS FIELD (8)** Indicates the trigger re-arming status (AUTO, NORMAL, SINGLE, STOPPED).
- During an acquisition the little box at the left of the re-arming status will indicate when an intermediate acquisition occurs. This feature helps to monitor the trigger rate before the waveform is reconstructed.
- For NORMAL status, a message SLOW TRIGGER may appear in the field when needed.
- For slow acquisition, a message SLOW UPDATE appears to remind the user that it will take a while before a new waveform will finish.
- The region just to the left of the trigger status field can contain messages showing that lengthy processes, such as FFT calculations on screen dumps, are under way.

GRID (9)	Displays traces from the acquisition or reference memories. A dual- or quad-grid presentation can also be selected in the display menu (see Chapter 18).
MENU FIELD (10)	This field is divided into seven sub-fields with menu buttons and two rotary knobs. Each field can display the name of a menu or perform an operation when the associated menu button is pressed. The RETURN button is used to restore the next higher menu level.
MESSAGE FIELD (11)	This field is used to display a variety of messages (warnings, indications, titles, etc..) that help the understanding of the instrument's current status.

TIMEBASE CAPABILITIES

Depending on the timebase setting, the following three sampling modes are possible:

- Single Shot
- Random Interleaved Sampling
- Roll Mode

For all time bases for which the single shot mode or roll mode can be used, the acquisition memory can be subdivided into user-defined segments to give:

- Sequence Mode

Single Shot

Single Shot acquisition is the basic acquisition technique of a digital oscilloscope. Other timebase modes of the oscilloscope make use of this single shot acquisition technique.

An acquired waveform consists of a series of measured voltage values sampled at a uniform rate on the input signal. The acquisition is typically stopped at a fixed time after the arrival of a trigger event as determined by the trigger delay. The acquisition consists of a single series of measured data values associated with one trigger event. The time of the trigger event is measured using the timebase clock. The horizontal position of a waveform is determined using the trigger event as the definition of time 0. Waveform display is also done with this definition. Since each channel has its own Flash ADC, the voltage on each of the input channels is sampled and measured at the same instant. This allows very reliable time measurements between different channels.

Trigger delay can be selected anywhere in a range that allows the waveform to be sampled from well before the trigger event up to the moment it occurs (100 % pretrigger), or at a time starting at the equivalent of 10000 divisions (at the current Time/div) after the trigger.

For fast time base settings the maximum single shot sampling rate of the Flash ADC's is used. This is 100 million samples per second (100 Ms/s). As the time base setting is increased, more and more data samples are used to fill the waveform until the maximum memory size of the waveform has been reached. For time bases slower than this, the sampling rate is decreased while maintaining the number of data samples in the waveform. The lowest sampling rate allowed is 1 sample/second. Single shot acquisition is allowed for all time base ranges slower than 50 ns/div.

TIMEBASE + TRIGGER

The 9310L and 9314L models allow single shot acquisitions containing up to 1 million samples. Because of the exceptional length of these waveforms there are some restrictions on their use. Processing functions are limited in length to 50000 points. Thus, the oscilloscope will not perform functions on waveforms with more than 50000 points. Also, ZOOM traces defined on large waveforms are limited to showing intervals containing up to 50000 points. The ZOOM traces can be positioned as usual when the acquisition is stopped. However, when an acquisition is underway, the data of the previously acquired waveform is no longer accessible. Waveform parameters will not be calculated for waveforms with more than 50000 points. The Internal Waveform Memories (M1, M2, M3, M4) are also limited to 50000 points. Therefore, large waveforms cannot be stored internally. Some of these restrictions may be removed in the future.

Random Interleaved Sampling

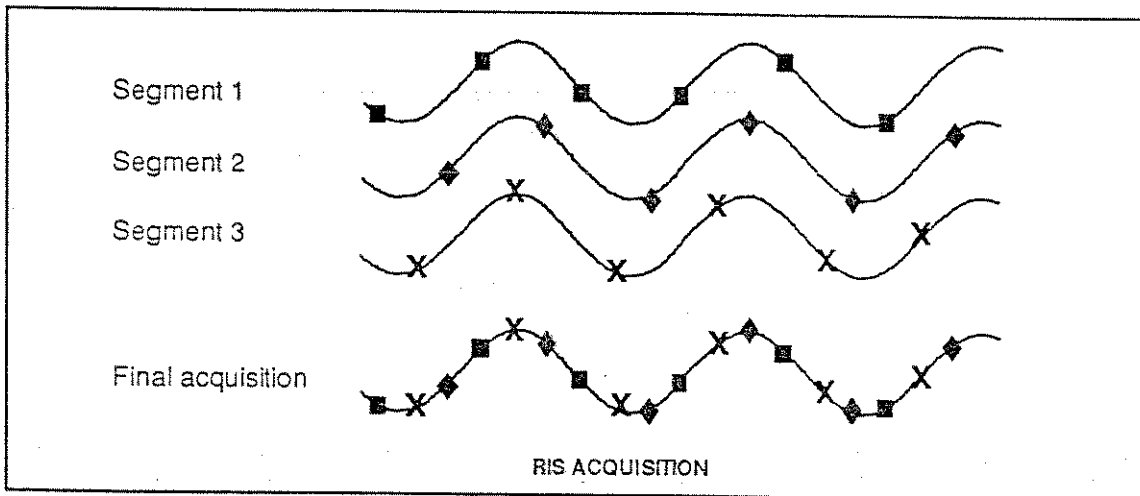

Random Interleaved Sampling (RIS) is an acquisition technique that allows effective sampling rates higher than the maximum single shot sampling rate (100 Ms/s), and can be used on repetitive waveforms with a stable trigger.

The maximum effective sampling rate of 10 Gs/s can be achieved by acquiring 100 single shot acquisitions at 100 MHz, with each single shot segment starting approximately 0.1 ns later than the

previous one. The process of acquiring 100 segments that satisfy this time constraint is random. The relative time between Flash ADC sampling instants and the event trigger provides the necessary variation. It is measured by the timebase to 15 ps (RMS) accuracy.

Typically, 520 trigger events may be needed to complete an acquisition, although sometimes many more are needed. These segments are interleaved to provide a waveform that covers a time interval that is a multiple of the maximum single shot sampling rate. However, the real time interval over which the data for the waveform has been collected is orders of magnitude longer and depends on the trigger rate and the level of interleaving desired. The oscilloscope is capable of acquiring approximately 10000 RIS segments per second.

RIS acquisitions are allowed for timebase settings from 1 ns/div up to the point at which a 200 Ms/s (5 ns/point) acquisition fills the available memory. At slower timebase settings there is no need to use the RIS technique.

RIS acquisitions do not have to be "complete" in order to be useful. A RIS acquisition can be stopped manually (STOP) or automatically (AUTO). The oscilloscope can treat RIS waveforms with missing segments.

Roll Mode

Single shot acquisitions at timebase settings slower than 0.5 s/div (10 s/div for 1 M records) have a sufficiently low data rate to allow the display of the incoming waveform in real time. The oscilloscope shows the incoming data continuously until a trigger event is detected and the acquisition is completed. The latest data is used to update a trace display that moves from right to left, similar to the output of a strip chart recorder.

Waveform MATH and Parameter calculations are done on the completed waveforms. The behavior of the STOP, SNGL, NORM, and AUTO buttons is modified when a roll mode acquisition is being used (see Chapter 9).

Sequence Mode

Sequence mode is an alternative to single shot acquisition, and provides many unique features. The complete waveform consists of a selectable number of fixed-size segments acquired in a single shot mode (see Appendix A for the limits). The dead time between the trigger events for consecutive segments can be kept to 150 μ s as opposed to the hundreds of milliseconds usually required between consecutive single shot waveforms. Complicated sequences

TIMEBASE + TRIGGER

of events covering a large time interval can be captured with fine details if there are uninteresting periods between the events. Time measurements can be done between events on different segments of a sequence waveform using the full precision of the acquisition time base. Trigger time stamps are given for each of the segments in the the TEXT & TIMES Status menu. Each individual segment can be displayed using the ZOOM capability or be used as input to the MATH package. For remote operation, sequence mode can be used to take full advantage of the high data transmission capability of the oscilloscope by overlapping the transmission of one waveform with the acquisition of its successor.

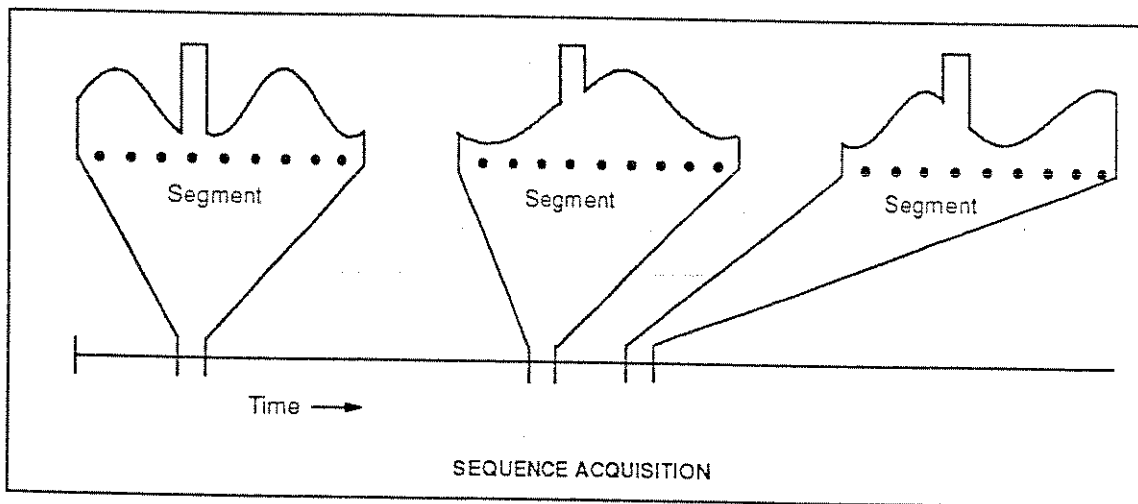

In sequence mode, the time base setting is used to determine the acquisition duration of each segment, which will be $10 \times \text{TIME/DIV}$. The time base setting, the desired number of segments, the maximum segment length and the total memory available for the oscilloscope model are used to determine the actual number of samples/segment and time/point to be used. The display of the complete waveform with all of its segments may not entirely fill the screen.

The Sequence mode is normally used to acquire the desired number of segments and terminate the waveform acquisition. It can also be used to acquire the segments continuously, overwriting the oldest ones as necessary. Then a manual STOP order or a timeout condition can be used to terminate the waveform acquisition. The

behavior of the STOP, SNGL, NORM, and AUTO buttons is modified when a sequence mode acquisition is being used (see Chapter 9). In order to ensure the low dead time between segments, button pushing and knob turning must be avoided during acquisition of sequences.

TRIGGER CAPABILITIES

The oscilloscope trigger is used to determine when to stop sampling data. The trigger possibilities have been divided into two classes:

- Edge – including:
 - simple threshold triggers on an input signal
 - window triggers on an input signal
 - LINE signal triggers
 - triggers with holdoff by time
 - triggers with holdoff by number of trigger events
- SMART – including triggers requiring one trigger signal:
 - GLITCH triggers on the pulse width of a trigger signal
 - Interval triggers on the interval between trigger transitions
 - TV triggers for composite video signals
 - DROPOUT trigger for transitions that cease after a while and
 - Qualified triggers which trigger on one signal after a transition on another signal with possible additional requirements

To capture rare phenomena such as glitches or spikes, missing bits, or intermittent faults, an oscilloscope must be able to trigger on elusive events. The 9304, 9310 and 9314 series of oscilloscopes offer a variety of sophisticated trigger modes. They are based on a counter which can be set by one signal and pre-set, to count a specified number of events of another signal (1 to 10^{*9}), or alternatively to measure time intervals up to 20 sec.

A discussion of each of the SMART triggers can be found in chapter 11, together with instructions on how to set them up.

EDGE TRIGGER

Single Edge triggers are described by a source, coupling, slope, and level condition. These same parameters are used to build up the SMART triggers.

The Edge triggers have a single source selected from:

- CH1, CH2 (CH3, CH4): the acquisition channel signal conditioned for the overall voltage gain, coupling, and bandwidth as described in Chapters 12 and 13.

- **LINE**: the line voltage which powers the oscilloscope. It can be used to provide a stable display of signals synchronous with the power line. Coupling and level are not relevant for this selection.
- **EXT**: the signal applied to the TRIG BNC connector. It can be used to trigger the oscilloscope within a range of ± 2 V.
- **EXT/10**: the signal applied to the TRIG BNC connector. It can be used to trigger the oscilloscope within a range of ± 20 V.

Coupling refers to the type of signal coupling at the input of the trigger circuit. Note that the trigger coupling can be selected independently for each of the sources. The DROPOUT and Qualified triggers use these selections. Therefore, a change of trigger source may also result in a change of the trigger coupling shown. The coupling choices are:

- **HF**: Used for triggering on high-frequency repetitive signals in excess of 300 MHz (175 MHz for the 9304). Maximum trigger rates greater than 500 MHz are possible (300 MHz for the 9304). HF triggering should be used only when needed. It will be automatically overridden and set to AC when it is incompatible with other characteristics of the trigger mode. This is the case for Window Triggers and the SMART triggers. Only one slope is available. It will be shown by the trigger symbol.
- **AC**: Signals are capacitively coupled; DC levels are rejected and frequencies below 50 Hz are attenuated.
- **LF REJ**: Signals are coupled via a capacitive high-pass filter network. DC is rejected and signal frequencies below 50 kHz are attenuated. The LF REJ trigger mode is used when stable triggering on medium to high frequency signals is desired.
- **HF REJ**: Signals are DC coupled to the trigger circuit and a low-pass filter network attenuates frequencies above 50 kHz. The HF REJ trigger mode is used to trigger on low frequencies.
- **DC**: All of the signal's frequency components are coupled to the trigger circuit. This coupling mode is used in the case of high-frequency bursts, or where the use of AC coupling would shift the effective trigger level.

Slope selects the direction of the trigger voltage transition to be used to generate a trigger event. The two traditional choices (Pos and Neg) have been extended to include the Window mode. In Window mode two trigger levels are defined and a trigger event

occurs when the signal leaves the middle window region in either direction.

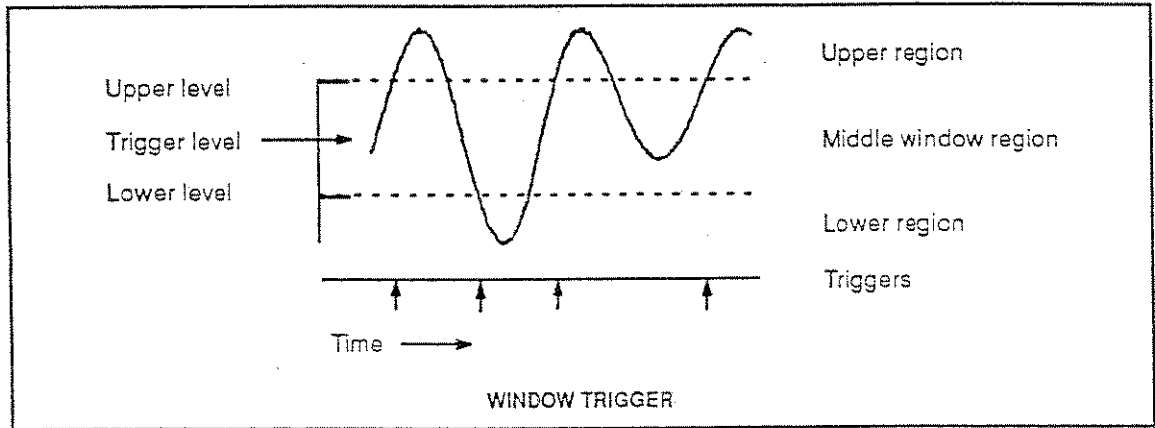

The selected slope is associated with a trigger source in the same way as the coupling.

Level defines the source voltage at which the trigger circuit will generate an event. The selected level is associated with a trigger source in the same way as the coupling. Note that the trigger level is specified in volts and is normally unchanged when the vertical gain or offset are modified.

The range of trigger levels is as follows:

- ± 5 screen divisions - with a channel as trigger source
- None with LINE as trigger source (zero crossing is used)
- ± 2 V with EXT as trigger source
- ± 20 V with EXT/10 as trigger source

EDGE Trigger with Holdoff

Holdoff is an additional characteristic of the trigger circuitry. When the Holdoff is Off, the time between successive trigger events is limited only by the input signal, the coupling and the oscilloscope's bandwidth.

Sometimes a stable display of complex repetitive waveforms can be achieved by putting a condition on this time. This holdoff is expressed either as a time or an event count. The time is measured starting at one trigger event, and the next event arriving after this

TIMEBASE + TRIGGER

time is allowed to trigger the oscilloscope. The event count is the number of trigger events to be ignored after one trigger event until the next one to be allowed. The choice of which holdoff mode is to be used depends on the application. Often, either one can be used to obtain the same result.

It should be noted that the holdoff is started by potential triggers and not at the end of an acquisition. Potential triggers will be accepted if the oscilloscope is ready, but will be ignored if the instrument is still busy handling the previous trigger event. In fact, the holdoff ensures synchronization between successive real triggers.

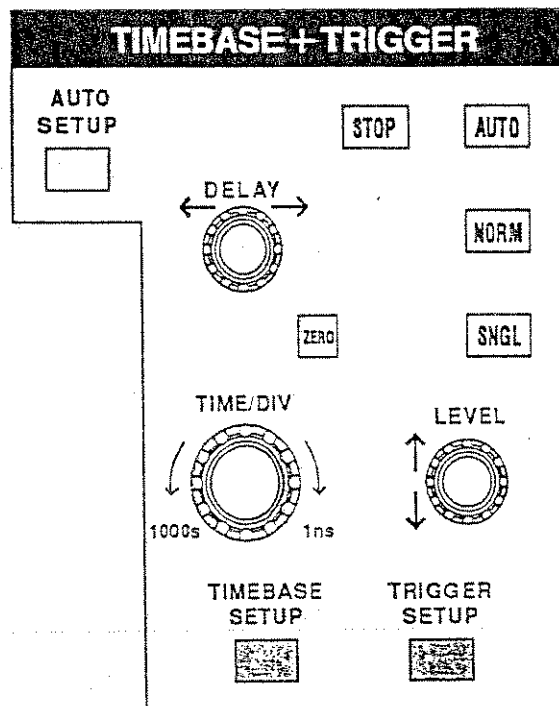
**STOP**

This button is used to halt the acquisition and can be used in all three re-arming modes (AUTO, NORM, SNGL). Pressing the STOP button prevents the oscilloscope from acquiring a new signal.

If the STOP button is pressed while a single-shot acquisition is under way, the last acquired signal will be kept.

If a RIS acquisition has been started, it will be stopped and a partial waveform reconstruction will be performed.

If the acquisition is in the ROLL mode, it will be stopped and the incomplete acquisition data will be shown as if a trigger had occurred.

For Sequence acquisitions, the timebase will be stopped and all the new segments will be shown.

AUTO

In AUTO mode, the oscilloscope automatically displays the signal if NO trigger occurs for more than 500 msec. If a trigger occurs within this time, the oscilloscope behaves as in NORMAL mode.

TIMEBASE + TRIGGER

For the RIS mode, the acquisition will be terminated and shown each second, although some needed segments may be missing.

For the ROLL mode, the oscilloscope samples the input signals continuously and indefinitely. The acquisition has no trigger condition but can be stopped as desired by the user.

For Sequence mode, the acquisition will be terminated if the time between two consecutive triggers exceeds a selectable timeout (see the UTILITIES menu under SPECIAL MODES). The next acquisition is then started from segment 1.

NORM

In this mode the screen is continuously updated as long as a valid trigger is present. If no valid trigger is present, the last signal is preserved and the warning "SLOW TRIGGER" is displayed in the Trigger Status Field.

For the RIS mode, the acquisition will normally be terminated once all the needed segments have been taken.

For the ROLL mode, the acquisition is terminated when the last needed data after a trigger have been taken. The display is paused, showing the entire waveform. After a moment it will go back into the roll mode while it waits for the next trigger.

For the Sequence mode, the acquisition is terminated after the last segment is acquired. The next acquisition is started immediately. A Sequence WRAP mode in NORMal is the same as in SINGLE.

SNGL

In Single Shot mode the instrument waits for one single trigger to occur, then displays the signal and stops acquiring. If no signal occurs, the button can be pressed again to show the signal being observed without a trigger.

When in RIS mode, (selected in TIMEBASE SETUP), the instrument will wait for all the trigger events required to build up ONE signal on screen before it stops (this may require as many as 4000 trigger events).

The ROLL mode is the same as single shot except that there is no need to push the button a second time to show the signal.

AUTO SETUP

This button automatically scales the timebase, trigger level, offset, and Volts/div to provide a stable display of REPETITIVE signals.

Auto-setup rules

- Auto Setup operates only on channels which are ON. If no channels are ON, then Auto Setup will operate on ALL the channels and will turn them all ON.

- Signals detected must have an amplitude between 2 mV and 40 V, a frequency greater than 50 Hz, and a duty cycle greater than 0.1%.
- If signals are detected on several channels, the channel with the lowest number will determine the selection of the timebase and trigger source.

DELAY	<p>This knob is used to adjust the pre- or post-trigger delay.</p> <p>Pre-trigger adjustment is available from 0 to 100% of the full time-scale, in steps of 1%. The pre-trigger delay is illustrated by the vertical arrow symbol on the bottom of the grid.</p> <p>Post-trigger adjustment is available from 0 to 10000 divisions in 0.1 division increments. The post-trigger-delay value is labelled in seconds and is located in the Trigger Delay Field on the screen.</p>
ZERO	<p>Pressing this button causes the trigger delay to be set to zero, i.e. the trigger instant is the left-hand edge of the grid.</p>
TIME/DIV	<p>This knob selects the time per division in a 1-2-5 sequence. The time/div setting is displayed in the Acquisition Summary field.</p>
LEVEL	<p>This knob adjusts the trigger threshold.</p> <p>Trigger level range:</p> <ul style="list-style-type: none"> - ± 5 screen divisions with a channel as trigger source - ± 2 V with EXT as trigger source - ± 20 V with EXT/10 as trigger source - Inactive with Line as trigger source <p>The trigger sensitivity is better than 1/3rd of a screen division.</p>
TIMEBASE SETUP	<p>This menu-entry key calls up the "TIMEBASE SETUP" menu described in chapter 10.</p>
TRIGGER SETUP	<p>This menu-entry key calls up the "TRIGGER SETUP" menu described in chapter 11.</p>

10 Timebase Setup

The Timebase Setup menu is used to select:

- Single-shot or Interleaved (RIS) acquisition
- External clock (Option CKIO)
- Sequence mode
- The number of segments in sequence mode
- The maximum record length (L and M models only)

The menu also shows the status of:

- The number of points acquired
- The sampling rate
- The total time span

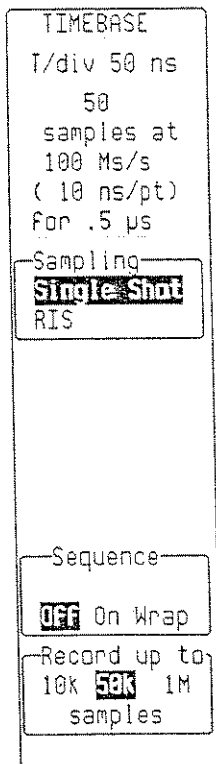

Sampling

Two essential modes of operation may be selected with this menu button:

- **Single Shot** – the oscilloscope displays data collected during successive single-shot acquisitions from the input channels. This mode allows captures of **non-recurring or very low repetition-rate events simultaneously on all the input channels.**
- **RIS** – the oscilloscope uses a Random Interleaved Sampling technique to achieve a higher effective sampling rate than in single-shot mode, provided the input signal is repetitive and the trigger is stable.

Sequence

On – In sequence mode, the acquisition memory is segmented, allowing sequential recording of single events. This is very useful when the time between the events is very short.

Wrap – Same as “Sequence On”, except that segments are acquired continuously. A Wrap mode acquisition can be terminated manually by pushing the STOP button, or automatically using the time-out feature of the AUTO mode.

Note: See “More on Sequence” on next page.

Record up to

Selects the maximum record lengths of the acquisition channels. (L and M models only). The 1M mode is allowed for Single Shot only.

MORE ON SEQUENCE

When Sequence is set to ON

1. If the trigger mode is SINGLE, the oscilloscope fills the segments and stops, or if there are not enough trigger events to fill the segments, it waits forever unless the STOP trigger mode button is pressed.
2. If the trigger mode is NORM, the oscilloscope fills the segments and then, if more trigger events occur, the acquisition is restarted from segment 1.
3. If the trigger mode is AUTO, and if the time between two consecutive triggers exceeds a selectable time-out, the acquisition is restarted from segment 1.

The time-out can be selected in the UTILITIES menu under SPECIAL MODES (chapter 19).

When Sequence is set to WRAP

The segments are filled continuously until the STOP trigger mode button is pressed. The last n segments will be displayed. An alternative way to stop the WRAP sequence is through AUTO mode: if the time between two consecutive triggers exceeds a selectable time-out, the acquisition will stop.

TIMEBASE
T/div 50 ns
50 * 50
samples at
100 Ms/s
(10 ns/pt)
for .5 μ s

Sampling
Single Shot

Sequence
50 segments
OFF Wrap

Max. segment
250
samples

Sequence

The menu button is used to select between Off, On and Wrap, and the menu knob is used to select the desired number of segments.

Max. segment

Selects via the menu knob/button the maximum record length for each segment.

Note: A summary of the acquisition conditions is displayed at the top of the menu: number of segments, available record length per segment, sampling rate, and timebase setting.

TIMEBASE + TRIGGER

EXTERNAL CLOCK

Oscilloscopes fitted with the option CKIO allow the user to supply clock signals at the External TRIG BNC input which will be used to drive the ADCs of the instrument. Additional menu fields allow the choice of the type of external clock signal and the size of the record to be acquired.

TIMEBASE
EXTERNAL
10000
samples at
1000 s/div

Sampling
Single Shot

Sample Clock
Internal
ECL 0 v TTL

Sequence
OFF On Wrap

Record
10K
samples

Sampling

This button is inactive when the external sample clock is being used. Only single-shot acquisition mode is available.

Sample Clock

Press this button to select the appropriate description of the signal applied to the TRIG BNC connector for use as the sample clock. The rising edge of the signal is used to clock the ADCs of the oscilloscope. The effective thresholds for sampling the input are:

- ECL - -1.3 V
- 0 V - 0.0 V
- TTL - +1.5 V

The risetime and falltime of the signal should both be less than 10 ms.

Sequence

This button is used to select Sequence Modes if desired. The knob is used to adjust the number of segments. Trigger time stamps are not available when the external clock is in use. The AUTO sequence timeout feature is not available. The intersegment dead time is no longer guaranteed.

Record

Use the knob to select the desired number of samples for the single-shot acquisition.

The time/div is now expressed in s/div which should be thought of as samples/div.

The trigger delay is also expressed in samples and can be adjusted as usual.

No attempt is made to measure the time difference between the trigger and the external clock. Therefore, successive acquisitions of the same signal can appear to jitter on the screen.

The oscilloscope will require a number of pulses (typically 50) before it recognizes the external clock signal. The acquisition is halted only when the trigger conditions have been satisfied and the appropriate number of data points have been accumulated.

Any adjustment to the time/division knob automatically returns the oscilloscope to normal (Internal) clock operation.

The Trigger Setup menu is used to select:

- The trigger mode
- The EDGE trigger settings
- SMART trigger settings that enable triggering on:
 - Glitches
 - Intervals
 - TV signals
 - State-qualified events
 - Dropouts

HOW THE TRIGGER MODES OVERLAP

Once specified, Trigger Level (i.e. threshold) and Trigger Coupling are the only parameters that are passed unchanged from mode to mode – and this is done for each trigger source.

CHOOSING THE TRIGGER MODE

The Trigger Setup menu can be displayed at any time by pushing the dark grey menu-entry key marked TRIGGER SETUP.

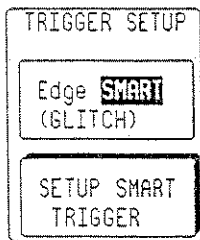

The top menu button allows the choice between EDGE and SMART triggers.

After activating the SMART trigger with the top menu button, all of the parameters for the current SMART trigger are shown for modification in the menu.

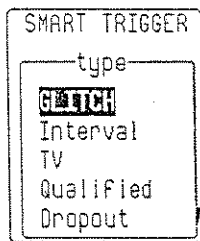

When SMART is selected, the SETUP SMART TRIGGER menu button gives access to a lower level menu where a different SMART trigger can be chosen. The top button in this menu gives the choice of SMART trigger types available.

TIMEBASE + TRIGGER

EDGE TRIGGER

- The EDGE mode is used to:
- Select a trigger source
 - Select the coupling for each source
 - Select the slope (positive, negative or window)
 - Define the holdoff in time or events

TRIGGER SETUP

Edge SMART

trigger on
1 2 3 4 Ext
Ext10 Line

coupling 1
DC AC LF-REJ
HF-REJ HF

slope 1
Pos Neg
Window

window size
+- 50mV
around level

holdoff
- - -
OFF Time Evts

Edge/SMART

Activates either Edge trigger or SMART trigger mode.

trigger on

Selects the trigger source in Edge mode.

coupling

Selects the trigger coupling for the current source.

slope

Defines the trigger point to be on either the positive or negative slope of the selected source. A third option, Window, allows triggering whenever the input signal leaves a specified voltage window (defined in the WINDOW SIZE field).

window size

When the Window option is selected in the field above, this field allows adjustment of the voltage window around a level defined with the trigger LEVEL knob.

holdoff

Simply stated, holdoff means that the oscilloscope's trigger circuit can be disabled for a definable period of time or number of events after a trigger event occurs.

By pressing the holdoff menu button, holdoff can be defined as:

- a period of time
- a number of events (an event being a change in the input signal that satisfies the trigger conditions)

The menu knob is used to vary the "holdoff" value.
Time holdoff values in the range 10 ns – 20 s may be entered.
Event counts in the range 1 – 10⁹ are allowed.

EDGE Trigger Symbols

Trigger Symbols are used to allow immediate recognition of the current trigger conditions. Examples of Edge trigger symbols are given in the following figure. The heavier transitions show where a trigger will be generated.

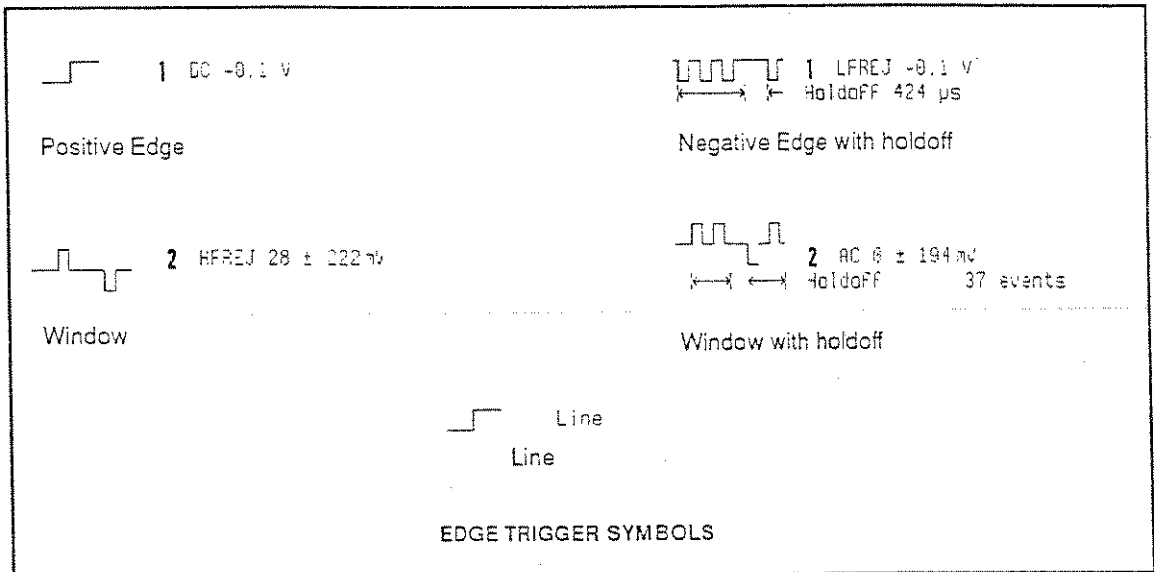

TIMEBASE + TRIGGER

SMART TRIGGER

TRIGGER SETUP
Edge SMART (GLITCH)
SETUP SMART TRIGGER
trigger on 1 2 3 4 Ext Ext10
coupling 1 DC AC LFREJ HFREJ
at end of NEG Pos pulse
width < OFF On
width > 10.0 ns OFF On

The following describes the SMART trigger setup menu (called up by pressing the SETUP SMART TRIGGER menu button).

After activating the SMART trigger with the top menu button, all of the parameters for the current SMART trigger are shown for modification in the menu.

The SETUP SMART TRIGGER menu button gives access to a lower level menu where a different SMART trigger can be chosen. The top button in this menu gives the choice of SMART trigger types available (see following pages).

GLITCH Trigger

The GLITCH trigger tests the pulse width – at the trigger level – of the input signal. It is mainly used to trigger on glitches (fast transitions) that may occur in a signal under test.

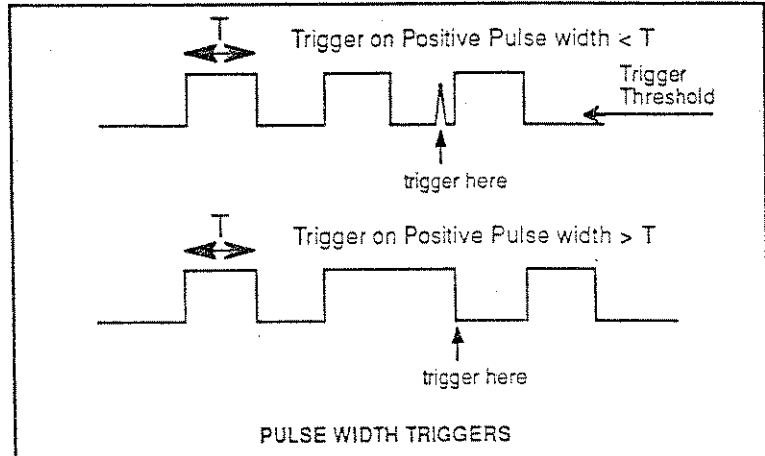

This trigger generates an event at the end of a pulse that satisfies the desired limits on its width. Both negative and positive pulses can be used. The width limits can be chosen as smaller or greater than a given value, within a time window, or outside a time window.

This feature offers a wide range of capabilities for application fields as diverse as digital and analog electronic development, ATE, EMI, telecommunications, and magnetic media studies. Catching elusive rare glitches becomes very easy. In digital electronics, where the circuit under test normally uses an internal clock, a glitch can be theoretically defined as any pulse with a width smaller than the clock period (or half period).

In a broader sense, a glitch can be defined as a pulse much faster than the waveform under observation.

Widths with 2.5 ns resolution starting at a minimum value of 2.5 ns can be selected. For recurrent glitches, the oscilloscope's random interleaved sampling mode allows glitch visualization with an equivalent sampling rate of up to 10 gigasamples/s, i.e. one sample point every 100 ps.

TIMEBASE + TRIGGER

SMART TRIGGER	
type	
GLITCH	
Interval	
TV	
Qualified	
Dropout	
trigger on	
1 2 3 4	
Ext Ext10	
coupling 1	
DC AC	
LFREJ HFREJ	
at end of	
Neg Pos	
pulse	
width <	
30.0 ns	
OFF On	
width >	
10.0 ns	
OFF On	

type

Select GLITCH trigger.

trigger on

Selects the source of the GLITCH trigger.

coupling

Selects the coupling of the GLITCH trigger.

at end of

Defines the test on either positive or negative pulses.

width <

Trigger if the pulse is smaller than the value defined in that field. The value can be adjusted with the menu knob associated with the field. The test can be turned on or off by pressing the menu button, and can be used in combination with the **width >** test.

Width values in the range 2.5 ns to 20 s may be entered.

width >

Trigger if the pulse is greater than the value defined in that field. The value can be adjusted with the menu knob associated with the field. The test can be turned on or off by pressing the menu button, and can be used in combination with the **width <** test.

The two width limits are combined to select glitches within a window if the width < value is greater than the width > value. Otherwise, they are combined to select glitches outside of the window.

Interval Trigger

Similar to GLITCH trigger except that the test is performed over an interval width rather than over a pulse width. See Figure below.

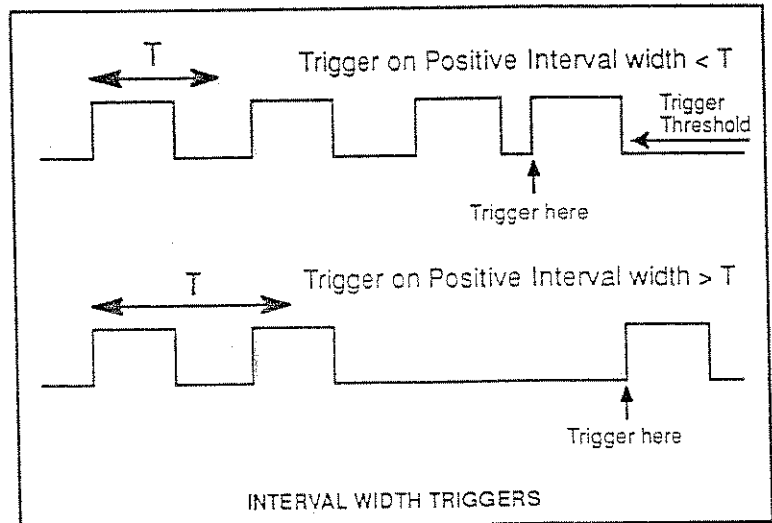

This trigger generates an event if the interval between two similar transitions of the trigger signal satisfy the desired limits. It is similar to the GLITCH trigger except that the lower time limit is 10 ns.

Missing bits in long data streams are easily triggered on using the interval width triggering facility. For ranging applications, Interval trigger may be used to ignore unwanted signal reflections.

TIMEBASE + TRIGGER

SMART TRIGGER

type
GLITCH
Interval
TV
Qualified
Dropout

trigger on
 2 3 4
Ext Ext10

coupling 1
 DC AC
LFREJ HFREJ

between
 Pos Neg
edges

interval <
142.5 ns
OFF On

interval >
70.0 ns
OFF On

type

Select Interval trigger.

trigger on

Selects the source of the Interval trigger.

coupling

Selects the coupling of the Interval trigger.

between

Defines the interval between two adjacent positive or negative edges.

interval <

Trigger if the interval is smaller than the value defined in that field. The value can be adjusted with the menu knob associated with the field. The test can be turned on or off by pressing the menu button, and can be used in combination with the **interval >** test.

Interval values in the range 10 ns to 20 s may be entered.

interval >

Trigger if the interval is greater than the value defined in that field. The value can be adjusted with the menu knob associated with the field. The test can be turned on or off by pressing the menu button, and can be used in combination with the **interval <** test.

The two interval limits are combined to select intervals within a window if the **interval <** value is greater than the **interval >** value. Otherwise, they are combined to select intervals outside of the window.

TV Trigger

The TV trigger allows stable triggering on standard or user-defined composite video signals. The oscilloscope can trigger on a specific line of a given field.

This trigger is a special form of the Edge Qualified trigger. A composite video signal on the trigger input is analyzed to provide a signal for the beginning of the chosen field (any, odd, or even) and a signal at the beginning of each line (see figure below). The field signal provides the starting transition and the beginning of line pulses are counted to allow the final trigger on the chosen line. The TV trigger includes an enhanced field counting capability which can maintain the trigger on a known field relative to some initial trigger (FIELDLOCK). The field, number of fields and the field rate, interlace factor, and number of lines/picture must be specified for this feature. Standard settings exist for the most popular forms of TV signals. The TV trigger can also function in a simple any line mode. Applications can be found wherever TV signals are present.

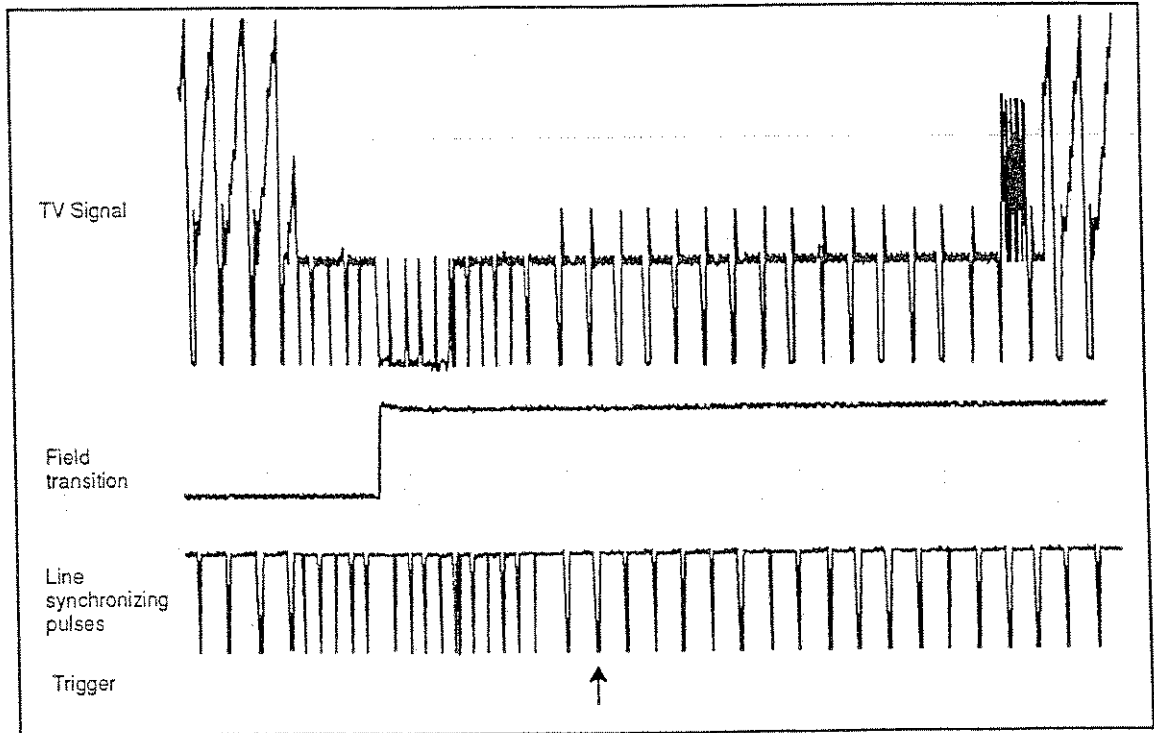

TIMEBASE + TRIGGER

SMART TRIGGER	
type	
GLITCH	
Interval	
TV	
Qualified	
Dropout	
TV signal on	
1	2 3 4
Ext	Ext10
# of fields	
1	2
4	8
TV type	
Standard	
Custom	
as	
625/50/2:1	
525/60/2:1	
trigger on	
Line	Field
315	2

type

Select TV trigger.

TV signal on

Selects the source of the TV trigger.

of fields

Defines the number of fields (up to 8).

TV type

Selects either standard or custom TV decoding.

as

When the TV type on the above field is set to standard, selects between 625/50/2:1 or 525/60/2:1 standard. When the TV type is set to custom, defines the number of lines, number of cycles, and interlacing factor for non-standard TV signals.

trigger on

Selects the line and field number the oscilloscope should trigger on.

NOTES

- A. Most TV systems have more than two fields and the enhanced field-counting capability (FIELDLOCK) allows the oscilloscope to trigger consistently on a chosen line within a chosen field of the signal. It should be noted that the field numbering system is relative in that the oscilloscope cannot distinguish between lines 1, 3, 5, and 7 (or 2, 4, 6, and 8) in an absolute way.
- B. For each of the characteristics the following remarks apply:
- 1) 625/50/2:1 (European style PAL and SECAM systems)
This setting should be used for most of the standard 50 field/sec signals. The lines may be selected in the range 1 to 626 where line 626 is identical to line 1.
Number of fields = 8 should be very useful for color PAL signals. Number of fields = 4 is appropriate for SECAM signals.
 - 2) 525/60/2:1 (American style NTSC systems)
This setting should be used for standard 60 field/sec NTSC signals. The lines are selectable in the range 1 to 1051, where line 1051 is identical to line 1.
Number of fields = 4 should be very useful for American-style NTSC systems.
 - 3) ?/50/?, ?/60/?
In order to allow maximum flexibility, no line-counting convention is used. The line count should be thought of as a line-synchronizing pulse count, and it includes the transitions of the equalizing pulses. For certain extreme cases of TV signals, the field transition recognition will no longer work. In this case, only the "any line" mode will be available.
- C. The enhanced field-counting capability cannot be used for RIS acquisitions.
- D. Composite video signals must have negative-going synch to be decoded correctly.

TIMEBASE + TRIGGER

Qualified Trigger

In this mode a transition of one signal above or below a given level, the validation, serves as an enabling condition to a second signal which is the source of the trigger. The trigger can occur either immediately after the validation, within a time limit after the validation, or after a predetermined time delay or count of potential trigger events. It is important to note that the time delay or trigger count is restarted at every validation. For the Qualified by state mode of this trigger, the amplitude of the first signal must remain in the desired state until the trigger occurs. In the Qualified by Edge mode, the validation is sufficient and there is no additional requirement placed on the first signal.

Typical applications can be found wherever time violations may occur, for example in micro-processor debugging or telecommunications.

Qualified By State Trigger

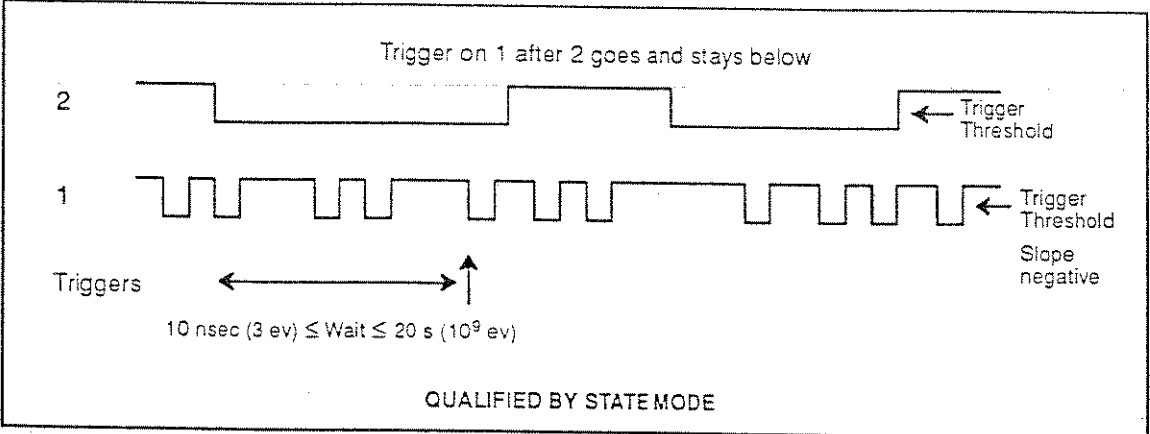

In State mode, the qualifier signal is valid when it goes and stays above (or below) a defined threshold. A trigger is accepted – while the qualifier signal is valid – after a given time or after a given number of trigger events. When the qualifier signal ceases to be valid, the time- and event-counters are reset.

SMART TRIGGER

type
 GLITCH
 Interval
 TV
Qualified
 Dropout

by
 Edge **State**
 (qualifier)

trigger on
 2 3 4
 Ext Ext10

only after
 1 2 3 4
 Ext Ext10

goes & stays
Above Below
 23mV

wait
 236 evts
 OFF T< T> **OFF**

type
 Select **Qualified** trigger.

by
 Select **State**.

trigger on
 Selects the trigger source. The other conditions for this source can be set up using an Edge trigger.

only after
 Selects the qualifier source. The other conditions for this source can be set up using an Edge trigger.

goes & stays
 The rotary knob adjusts the qualifier threshold and the pushbutton determines whether the qualifier signal is valid above or below that threshold.

wait
 Specifies the time limit (T<) for accepting the trigger event. Alternatively, it specifies how much time (T>) or how many trigger events (Evs) should be allowed before the acquisition is taken on the next trigger event. The qualifier signal must remain valid until the final trigger has been received.
 The time value can be chosen in the range 10 ns – 20 s.
 The trigger event count can be chosen in the range 1 – 10⁹.

Qualified By Edge Trigger

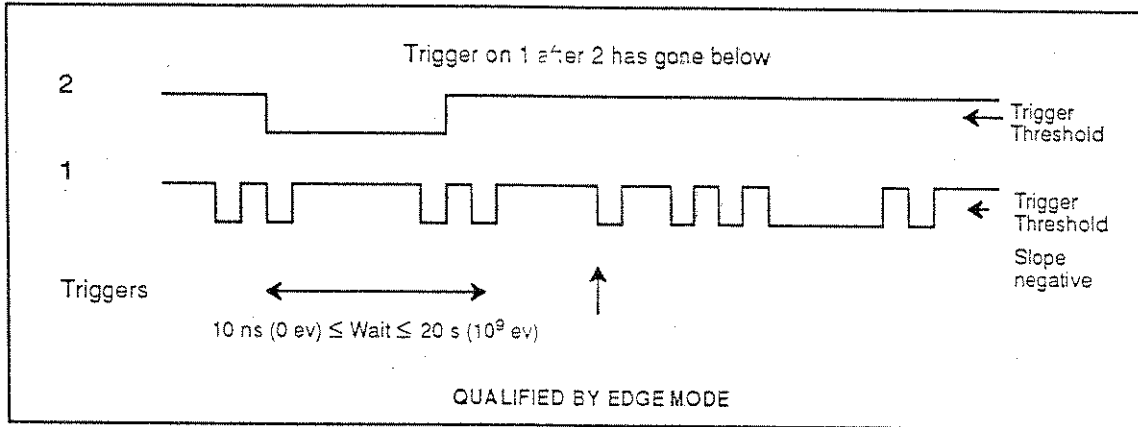

In Edge mode, the qualifier signal is valid as soon as it has gone above (or below) a defined threshold (valid transition). A trigger is accepted within a time or after a given time or number of trigger events. However, as soon as a valid transition occurs, the time- and event-counters are reset.

SMART TRIGGER

type
 GLITCH
 Interval
 TV
Qualified
 Dropout

by
Edge State
 (qualifier)

trigger on
 1 2 3 4
 Ext Ext10

after
 1 2 3 4
 Ext Ext10

has gone
Above Below
 23 mV

wait

OFF T< T> Evs

type

Select Qualified trigger.

by

Select Edge.

trigger on

Selects the trigger source. The other conditions for this source can be set up using an Edge trigger.

after

Selects the qualifier source. The other conditions for this source can be set up using an Edge trigger.

has gone

Adjusts the qualifier threshold and determines whether the qualifier signal is valid once it has gone above or below that threshold.

wait

Specifies the time limit (T<) for accepting the trigger event. Alternatively, it specifies the delay in time (T>) or number of trigger events (Evs) after a valid transition has occurred. A trigger can only be accepted after this delay

Note: Any subsequent qualifier event restarts this count.

The time value can be chosen in the range 10 ns – 20 s.

The trigger event count can be chosen in the range 1 – 10⁹.

TIMEBASE + TRIGGER

Dropout Trigger

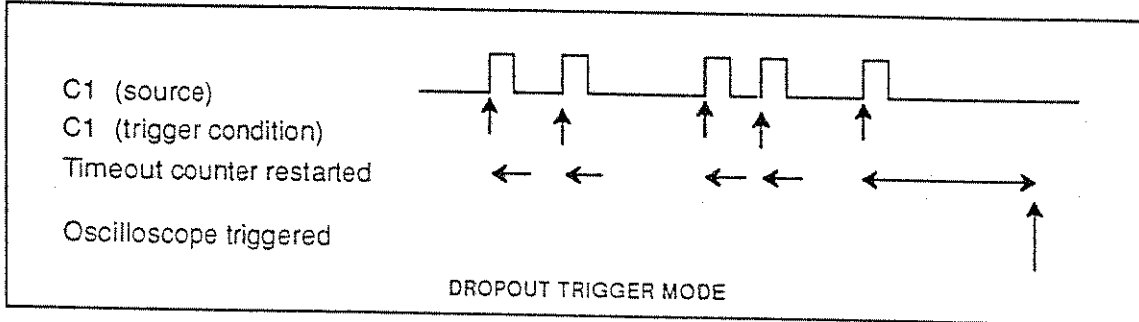

In this mode, a trigger is generated if edge-like signal transitions cease on the trigger source for the timeout value selected. The trigger event is generated at the end of the timeout period following the "last" trigger source transition.

A typical application is to look at the last "normal" interval of a signal that has disappeared completely. This is an essentially single shot application, usually with a pre-trigger delay. A RIS acquisition does not make any sense since the timing of the trigger timeout is not sufficiently well correlated with the input channel signals.

SMART TRIGGER

type
GLITCH
Interval
TV
Qualified
Dropout

Trigger after
timeout, if
NO edge

occurs on
 2 3 4
Ext Ext10

with slope
Positive
Negative

within
1.30 μ s
(timeout)
of previous
edge

type

Select Dropout trigger.

trigger after timeout, if NO edge occurs on

Selects the Dropout trigger source.

with slope

Defines whether the measurement has to be made starting on a Positive or Negative slope of the trigger signal.

within... of previous edge

Defines the time-out value in the range 25 ns – 20 s.

TIMEBASE + TRIGGER

SMART Trigger Symbols

Trigger Symbols are used to allow immediate recognition of the current trigger conditions. Examples of SMART trigger symbols are given in the following figure. The heavier transitions show where a trigger will be generated.

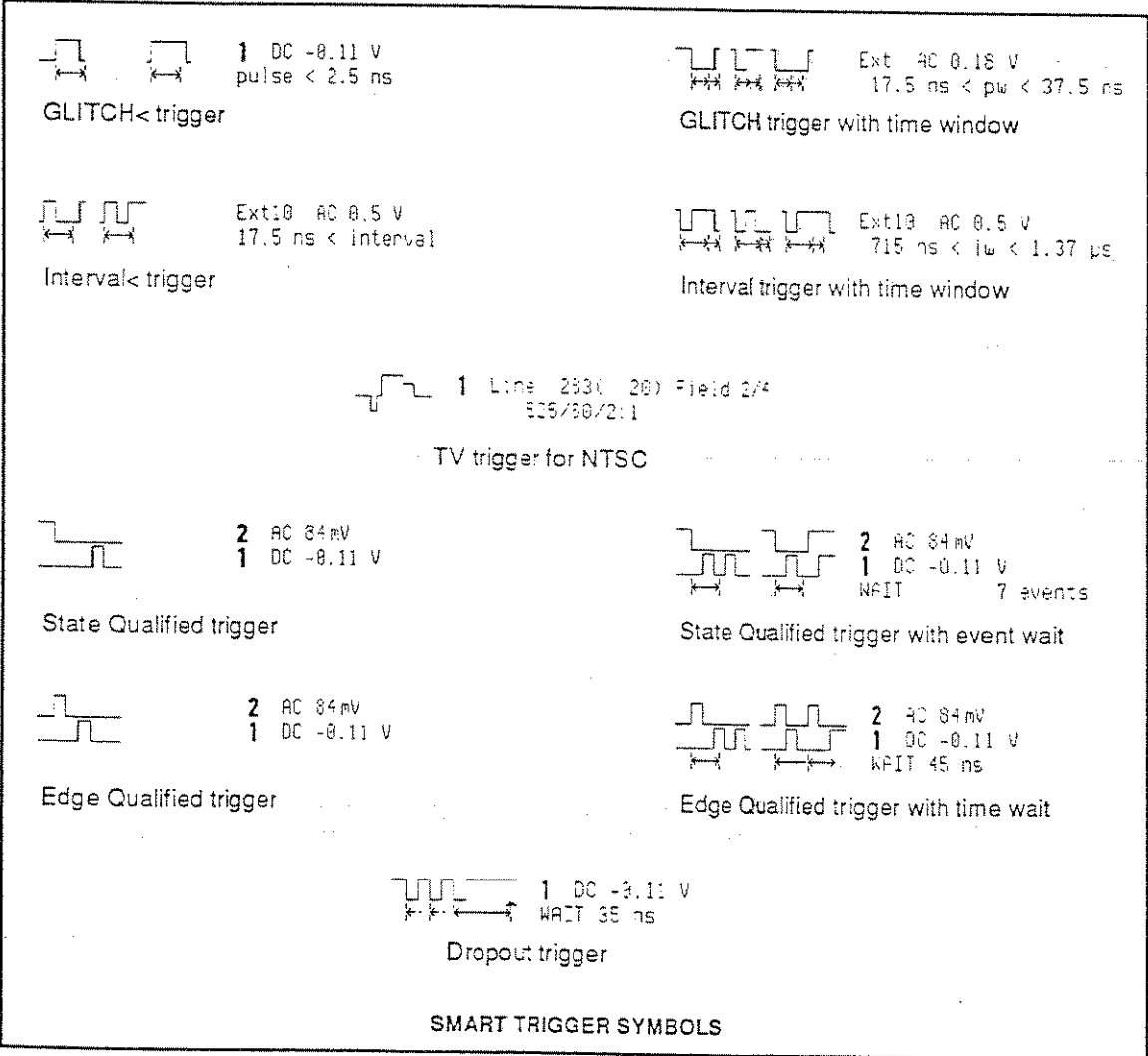

2-channel oscilloscopes

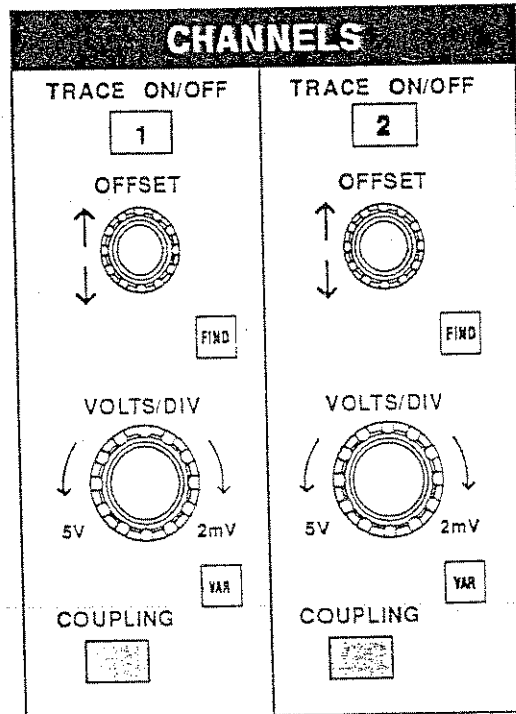

TRACE ON/OFF

Pressing a TRACE ON/OFF button causes the corresponding channel trace to be displayed or to be switched off.

OFFSET

This knob vertically positions the channel.

FIND

This button automatically adjusts the offset and the volts/div to match the input signal in the channel.

VOLTS/DIV

Selects the vertical sensitivity factor in a 1-2-5 sequence, or continuously (see VAR). The effect of gain changes on the acquisition offset can be chosen as described in the SPECIAL MODES menu (chapter 19).

VAR

This button allows the user to select whether the VOLTS/DIV knob modifies the vertical sensitivity in a continuous manner or in discrete 1-2-5 steps.

CHANNELS

The format of the vertical sensitivity in the acquisition summary field (bottom left of the screen) shows whether the VOLTS/DIV knob is operating in the "continuous" or "stepping" mode.

COUPLING

This button calls up the COUPLING menu described in chapter 13.

4-channel oscilloscopes

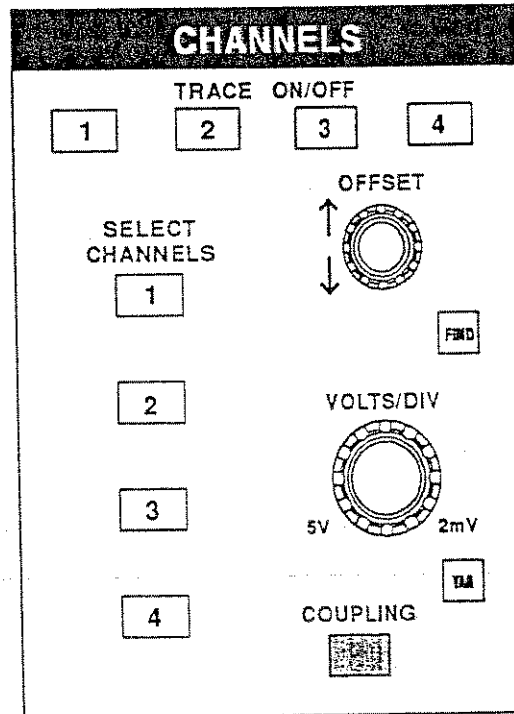
**TRACE ON/OFF**

Pressing a TRACE ON/OFF button causes the corresponding channel trace (1, 2, 3 or 4) to be displayed or to be switched off. The OFFSET and VOLTS/DIV controls will then be attributed to this channel, which will be referred to as the active channel.

SELECT CHANNEL

The SELECT CHANNEL buttons cause the corresponding channel to become active (i.e. all the vertical controls will be attributed to it). This control is independent of whether the channel is displayed or not.

OFFSET

This knob vertically positions the active channel.

FIND

This button automatically adjusts the offset and the volts/div to match the input signal in the active channel.

CHANNELS

- VOLTS/DIV** Selects the vertical sensitivity factor in a 1-2-5 sequence, or continuously (see VAR). The effect of gain changes on the acquisition offset can be chosen as described in the SPECIAL MODES menu (Chapter 19).

- VAR** This button allows the user to select whether the VOLTS/DIV knob modifies the vertical sensitivity in a continuous manner or in discrete 1-2-5 steps.

 The format of the vertical sensitivity in the acquisition summary field (bottom left of the screen) shows whether the VOLTS/DIV knob is operating in the "continuous" or "stepping" mode.

- COUPLING** This button calls up the COUPLING menu described in chapter 13.

The Coupling menu is used to select:

- The coupling and grounding of each input channel
- ECL or TTL gain, offset and coupling preset for the channel shown
- The probe attenuation of each input channel
- The bandwidth limiter for all of the channels

Note: On 4-channel models the SELECT CHANNEL buttons on the front panel allow the selection of the channel number in the COUPLING menu. On 2-channel models, a dedicated COUPLING menu button is available for each channel.

Channel 1

Coupling

DC-500

Grounded

DC1M Ω

Grounded

AC1M Ω

V/div Offset

NORMAL

ECL TTL

Global BWL

OFF On

(30 MHz)

Probe Atten

x1 x10 x100

x1K x10K

Coupling

Selects the coupling of the input channel. If an OVERLOAD condition is detected on a channel, the instrument will automatically set this channel to the grounded state. The button will then show OVERLOAD.

V/div Offset

If NORMAL is highlighted, pushing the button once sets the offset, Volts/div, and input coupling to properly display ECL signals. Pushing the button a second time gives the settings for TTL signals. Pushing the button once more returns the settings to those used at the last manual setup of the channel.

Global BWL

Sets the bandwidth limit OFF or ON

The bandwidth can be reduced from 300 MHz to 30 MHz (from 175 MHz to 20 MHz for the 9304)(-3dB). Bandwidth limiting may be useful in reducing signal and system noise or preventing high-frequency aliasing. For example, bandwidth limiting reduces any high-frequency signals that may cause aliasing in single-shot applications.

Note: This command is global and affects all the input channels.

Probe Atten

Sets the probe attenuation factor related to the input channel.

CHANNELS

MORE ON COUPLING

In the AC position, signals are coupled capacitively, thus blocking the input signal's DC component and limiting the signal frequencies below 10 Hz.

In the DC position, all signal frequency components are allowed to pass through, and 1 M Ω or 50 Ω may be chosen as the input impedance. It should be noted that with 1 M Ω input impedance the bandwidth is limited to approximately 250 MHz.

The maximum dissipation into 50 Ω is 0.5 W, and inputs will automatically be disconnected whenever this occurs. An indication of the overload can be found in the Acquisition Summary Field and in this menu. The overload condition is reset by removing the signal from the input and selecting the 50 Ω input impedance again.

PROBES

Model P9020 passive probes are supplied with the oscilloscope. These probes have 10 M Ω input impedance and 16 pF capacitance. The system bandwidth with these probes is DC to 250 MHz (typical) in 1 M Ω DC coupling, and >10 Hz to 250 MHz in AC coupling.

To calibrate the P9020 probe, connect it to one of the input channels BNC connectors. Connect the probe's grounding alligator clip to the CAL BNC ground and touch the tip to the inner conductor of the CAL BNC. The CAL signal is a 1 kHz square wave, 1 V p-p.

Set the channel coupling to DC 1 M Ω , turn the trace ON and push AUTO SETUP to set up the oscilloscope. If over- or undershoot of the displayed signal occurs, it is possible to adjust the probe by inserting the small screwdriver, supplied with the probe package, into the trimmer on the probe's barrel and turning it clockwise or counter-clockwise to achieve the optimal square-wave contour.

A wide range of processing functions can be performed on acquired waveforms. These capabilities are accessed through the ZOOM + MATH controls on the front panel.

Four (processed) traces, A, B, C, and D are available for either zooming alone or for waveform mathematics.

ZOOM

Any trace, A, B, C or D, can be set up to zoom onto any of the acquired traces C1, C2 (C3, C4), any of the reference memories M1 – M4 (see chapter 20 on storing waveforms), or any of the other traces A, B, C or D (but not itself). The Displayed Trace field will show the source of the ZOOM. The four rotary knobs of this front-panel section are used to manipulate the horizontal and vertical positions and the horizontal and vertical expansion factors of the zoomed trace. When several traces are displayed, the controls must be assigned to the desired trace with the SELECT A B C D button, since only one trace can be modified at a time.

Precise Timing Measurements with Zooming

Even on the models with 10K points per channel, the horizontal expansion factor can be as large as 200, greatly improving the time resolution on the viewed trace. It is possible to have several traces zoom onto the same waveform for precise timing measurements.

As an example, consider a waveform where the time interval between two signal transitions which are about 500 μ s apart must be measured accurately. This waveform should be acquired with a .1 ms/div timebase so that the transitions appear on the screen about 5 horizontal divisions apart. Trace A can now be set up to zoom onto the first transition of the signal, while trace B is set up to zoom onto the second transition.

In an instrument with 50 K points per channel, the traces can be expanded to as much as .1 μ s/div, i.e. a factor 1000. By applying the "relative" "horizontal" cursors (see chapter 22), the 500 μ s time interval can be measured with a resolution of better than 5 ns. Thus, the combination of long memory with zooming allows time interval measurements with an accuracy of 1 to 100000.

Multi-Zoom

It is sometimes convenient to be able to move the zoomed (intensified) region along two or more different traces, or two or more regions of the same trace, simultaneously. When the Multi-Zoom feature is turned on in the MATH SETUP menu, the horizontal zoom and position controls apply simultaneously to all displayed traces A, B, C and D, allowing a convenient simultaneous viewing of similar

sections of different traces. The vertical controls still act individually on the traces, and can be switched from one trace to another with the SELECT A B C D button. The boxes around the trace titles in the Displayed Trace Field show whether the Multi-Zoom is on or off.

Viewing Reference Memories

The reference memories M1 – M4 cannot be displayed directly. They must be viewed through one of the traces A, B, C or D, and the menu MATH SETUP is used to define the trace as a zoom on the desired reference memory. A shortcut is available in the menu RECALL WAVEFORM (chapter 21), in which it is possible to “recall” a reference waveform into one of the traces A, B, C or D. Whenever such a “recall” is executed, the destination trace is redefined as a zoom of the reference memory and the trace display is turned on. The previous definition of the destination trace is lost.

WAVEFORM MATHEMATICS

Any trace A, B, C or D can be set up as a mathematical function. Waveform negation, identity, addition, subtraction, multiplication and division, as well as summed averaging of up to 1000 waveforms, are standard. The waveform processing options WP01 and WP02 offer a wide range of additional possibilities:

- continuous averaging
- summed averaging of up to 1000000 waveforms
- enhanced resolution by up to 3 bits with filtering
- extrema, i.e. envelope of many waveforms
- mathematical functions, such as integral, derivative, logarithm, exponential, square, square root and $\sin x/x$ interpolation
- Fast Fourier Transform (option WP02), including FFT averaging

Waveform mathematics can be applied to any channel C1, C2 (C3, C4) or any reference memory M1 – M4. Also, they can be applied to the traces A, B, C or D so that several computations can be executed in sequence. For example, trace A can be set up as the difference between C1 and C2; then, trace B can be defined as the average of A; finally, trace C can be the integral of B. Thus, trace C displays the integral of the averaged difference between channels 1 and 2.

In order to avoid slowing the instrument down for unwanted computations, a mathematical function is only computed when its display is turned on. However, in the example above, it would be sufficient to display trace C only: the instrument knows that it must compute A and B as intermediate steps to C.

The Displayed Trace field will show a processing title for each trace on display. If the title is missing, it is an indication that the processing desired cannot be done and the contents of the trace have been left unchanged.

Zoom of Math Functions

When a trace A, B, C or D is defined as a mathematical function (rather than a Zoom only), the zoom controls are still operating. Thus, it is not necessary to define another trace as a zoom of this function. In order to view the entire mathematical function, cancel any expansion or position change by pressing the button RESET.

Speed-up of Waveform Mathematics

Waveform processing can take an appreciable execution time when operating on many data points. The time, however, can be reduced by limiting the number of data points which are used in the computation. The instrument then executes the waveform processing function on the entire waveform by taking every Nth point, where N depends on the timebase and the desired maximum number of points. The first point of such a reduced record is always the data value at the left-hand edge of the screen.

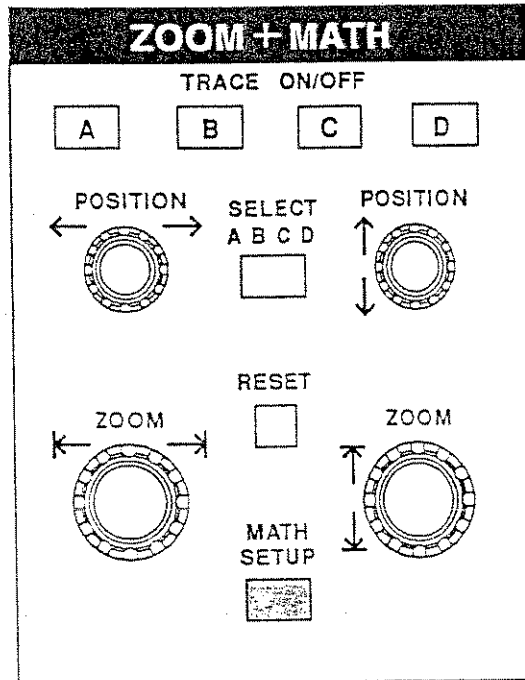

Handwritten text on the right side of the page, including the number '1' and some illegible characters.

**TRACE ON/OFF**

Pressing a TRACE ON/OFF button causes the corresponding trace (A, B, C or D) to be displayed. The POSITION and ZOOM knobs together with the RESET button will then be attributed to this trace, which will be referred to as the active trace.

SELECT TRACE

If more than one trace is displayed, the SELECT ABCD button causes the next trace (in the ABCD sequence) to become active.

↔ POSITION

Horizontally repositions an expanded trace. If the source of the expanded waveform is displayed, it will show an intensified region corresponding to the area of expansion.

↕ POSITION

Vertically repositions the active trace.

↔ ZOOM

Horizontally expands/contracts the active trace. If the source of the expanded trace is also displayed, it will show an intensified region corresponding to the area of expansion.

ZOOM + MATH

⇕ ZOOM

Vertically expands/contracts the active trace. The ⇕ position is adjusted according to the selection made in the SPECIAL MODES menu (chapter 19).

RESET

This button resets any previously adjusted ↔ POSITION, ⇕ POSITION, ↔ ZOOM or ⇕ ZOOM to the initial values of the source trace.

MATH SETUP

This button calls up the MATH SETUP menu described in chapter 16. In addition to the definition of the traces A, B, C, D, this menu also controls the multi-zoom mode and the choice of sequence segment displayed by an expand.

The Math Setup menu is used to select:

- Zoom features: vertical, horizontal, multi-zoom, etc...
- Math features: Arithmetic, Average, Enhanced Resolution, Envelope, Fast Fourier Transform (FFT), and various functions such as integral, exponential, square root...
- A sequence segment to be displayed (see chapter 8 for a description of Sequence mode).

HOW TO USE MATH

Four traces (A,B,C,D) are provided for "Math" usage. They can be configured to execute any Zoom or Math function, AND they can be chained. For instance:

- Trace A can be configured to be an averaging of Channel 1
- Trace B can be a Fourier Transform (FFT) of A
- Trace C can be a Zoom of B

All these traces can be seen SIMULTANEOUSLY on the screen by pressing the required TRACE ON/OFF buttons. Also, any function can be zoomed directly.

STANDARD AND OPTIONAL PROCESSING PACKAGES

The standard Waveform Processing features of the instrument include Summed Averaging up to 1000 sweeps and Arithmetic operations (Add, Subtract, Multiply, Divide, Negate, Identity).

The WP01 optional Waveform Processing firmware adds the following functionalities:

Summed Averaging up to 1 million sweeps, Continuous Averaging up to 1024 sweeps, Reciprocate, Rescale, Absolute Value, Derivative, Integral, Logarithm (e), Logarithm (10), Exponential (e), Exponential (10), Square, Square Root, $(\sin x)/x$ interpolation.

Enhanced Resolution: digital filtering allows 0.5- to 3-bit vertical resolution improvement.

The WP02 optional Waveform Processing firmware adds frequency domain analysis (FFT and FFT Power Averaging), as well as Rescale in both time and frequency domains.

ZOOM + MATH

ZOOM + MATH
REDEFINE A A=1
REDEFINE B B=2
REDEFINE C C=1
REDEFINE D D=2
Multi-Zoom OFF On
A Selected Segment 14 All Segments
For Math use at most 25000 points

REDEFINE

Selects the trace to be redefined in the Setup menu. The various Setup menus are described in the rest of this chapter.

Multi-Zoom

When Multi-Zoom is ON, all the "Zoom" traces are simultaneously controlled by the POSITION and ZOOM knobs.

When Multi-Zoom is switched OFF, only the active trace (selected by pressing the SELECT ABCD button) is controlled by the POSITION and ZOOM buttons.

Selected

When a trace A...D which contains a Sequence mode waveform is selected, this box appears in the menu. It is used to select either a specific segment to be displayed in the trace or all the segments at once. Pressing the menu button toggles between a single Segment and All Segments. When a single segment is selected, the associated rotary knob can be used to step through the segments.

for Math use at most...

Selects the maximum number of points for all Math operations. Selecting a low number increases computation speed.

SETUP MENU FOR ZOOM

Setup of A

use Math?

No Yes

Trace A is
ZOOM of

<input checked="" type="checkbox"/>	2	3	4	B	C	D
	M1	M2	M3	M4		

use Math?

Toggles between No (Zoom only) and Yes (Math + Zoom) setup.

Trace ... is ZOOM of

Selects the source trace on which the zoom will be applied.

ZOOM + MATH

SETUP MENU FOR ARITHMETIC

This menu allows addition, subtraction, multiplication and division. The two operands and the operator may be chosen in the three lower fields.

The menu illustrated on this page shows a setup of trace A as the sum of Channel 1 and Channel 2.

Setup of A
use Math? No Yes
Math Type Arithmetic Average Enh. Res Extrema FFT
Sum Difference Product Ratio
1 2 B C D M1 M2 M3 M4
plus 1 2 B C D M1 M2 M3 M4

use Math?
Select Yes.

Math Type
Select Arithmetic.

**SETUP MENU FOR
AVERAGE**

This menu allows summed (linear) averaging or continuous (exponential) averaging.

Summed averaging consists of the repeated addition, with equal weight, of successive source waveform records. If a stable trigger is available, the resulting average has a reduced random noise component, compared with a single-shot record. Whenever the maximum number of sweeps is reached, the averaging process stops. The process may be interrupted by switching the trigger mode from NORM to STOP or by turning the function trace OFF. Averaging will continue when these actions are reversed.

The accumulated average may be reset by either pushing the CLEAR SWEEPS button or by changing an acquisition parameter, such as input gain, offset or coupling, trigger condition, time base or bandwidth limit. The number of currently averaged waveforms (of the function or of its expansion) is displayed in the Displayed Trace field.

Whenever the maximum number of sweeps is reached, a larger number of sweeps may be accumulated by simply changing the maximum number of sweeps in the setup menu. In this case care must be taken to leave the other parameters unchanged, otherwise a new averaging calculation is started.

When summed averaging is turned on, the display is updated at a reduced rate (about once every 1.5 sec), to increase the averaging speed (points per second and events per second).

Summed averaging can be applied to sequence waveforms to give the average of the segments. It can also be applied to an expansion showing a segment of a sequence, to give the average waveform for that segment over many sequence acquisitions.

Continuous averaging (also called exponential averaging) consists of the repeated addition, with unequal weight, of successive source waveforms. The technique is particularly useful for reducing noise on signals which drift very slowly in time or amplitude. However, the statistics of a continuous average tend to be worse than those from a summed average on the same number of sweeps, since the most recently acquired waveform has more weight than all previously acquired ones. Therefore, the continuous average is dominated by the statistical fluctuations of the most recently acquired waveforms.

The weight of "old" waveforms in the continuous average gradually tends to zero, at a rate which decreases as the weight increases.

ZOOM + MATH

The menu below shows a setup of trace A as a Summed Average – over 1000 sweeps – of Channel 1.

SETUP OF A

use Math?
No **Yes**

Math Type
Arithmetic
Average
Enh. Res
Extrema
FFT

Avg Type
Summed
Continuous

for
1000
(sweeps)

of
1 2 3 4 B C D
M1 M2 M3 M4

use Math?

Select Yes.

Math Type

Select Average.

Avg Type

Selects between Summed and Continuous Average.

for... / weight

In Summed Averaging mode, this field is used to define the number of sweeps desired for the operation. In Continuous Averaging mode, this field is used to define the weight (similar to the number of sweeps) desired for the operation.

In other words, in summed averaging, "for n sweeps" means the *first* n sweeps will be taken into account. In continuous averaging, "weight 1 : n" means that the last sweep will be given a weight of 1 and the previous result a weight of n in calculating the new average.

of

Selects the source trace to be averaged.

SETUP MENU FOR ENHANCED RESOLUTION

This menu allows the selection of low-pass digital filters which increase the resolution of the displayed signal to the detriment of its bandwidth. Appendix B gives a detailed explanation.

Note: These digital filters work very much like analog bandwidth-limit filters. In single-shot mode, these filters, as well as the sampling speed, affect bandwidth. If high bandwidth is needed at slow timebases, consider using averaging and repetitive sampling.

SETUP OF

use Math?
No **Yes**

Math Type
Arithmetic
Average
Enh Res
Extrema
FFT

enhance by
1 bit
1.5 bits
2 bits
2.5 bits
3 bits

<input type="checkbox"/>	2	3	4	B	C	D
	M1	M2	M3	M4		

use Math?

Select Yes.

Math Type

Select Enhanced Resolution.

enhance by

Selects the different filters which will enhance the resolution of the displayed signal from 1 to 3 bits in 0.5-bit steps. The last box on the menu allows selection of the source trace to be filtered.

**SETUP MENU FOR
EXTREMA**

This menu is used to acquire the envelope of a trace over many acquisitions.

Extrema waveforms are computed by a repeated comparison of successive source waveform records with the already accumulated extrema waveform, which consists of a maxima record (roof) and a minima record (floor). Whenever a given data point of the new waveform exceeds the corresponding maximum value in the roof record, it replaces it. If the new data point is smaller than the corresponding floor value, it replaces it. Thus the maximum and the minimum envelope of all waveform records is accumulated.

Roof and Floor records can be displayed individually or both together.

Whenever the selected maximum number of sweeps is reached, the accumulation process stops. The process may be interrupted by switching the trigger mode from NORM to STOP or by turning the function trace OFF. Accumulation will continue when these actions are reversed. The currently accumulated extrema waveform may be reset by either pushing the CLEAR SWEEPS button or by changing an acquisition parameter, such as input gain, offset or coupling, trigger condition or the time base or bandwidth limit. The number of currently accumulated waveforms is displayed in the Displayed Trace field of the function or of its expansion.

A larger number of sweeps may be accumulated by simply changing the maximum number of sweeps in the setup menu. In this case, care must be taken to leave the other parameters unchanged, otherwise the extrema calculation is started again.

SETUP OF A

use Math?
No **Yes**

Math Type
Average
Enh. Res
Extrema
FFT
FFTAVG

limits
Envelope
Floor Roof

for
1000
(sweeps)

of
1 2 3 4 B C D
M1 M2 M3 M4

use **Math?**
Select **Yes**.

Math Type
Select **Extrema**.

limits
Selects between **Envelope**, **Floor** and **Roof**. **Floor** is used to show only the lower part of the envelope and **Roof** to show only the upper part of the envelope. Changing the limits does not force the analysis to start again.

for
Selects the number of sweeps desired for the operation.

of
Selects the source trace.

ZOOM + MATH

SETUP MENU FOR FFT

This menu is used to display the Fast Fourier Transform (FFT) of a signal in order to visualize it in the frequency domain. More details of Fast Fourier Transform are given in Appendix C.

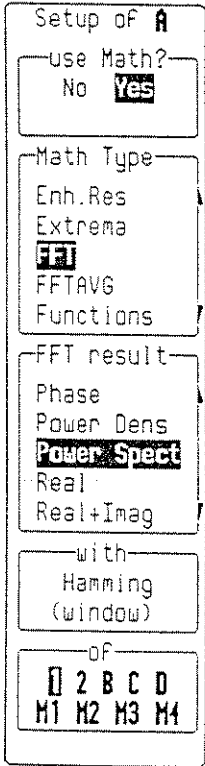

use Math?

Select Yes.

Math Type

Select FFT.

FFT result

Selects the output format of the FFT: Imaginary, Magnitude, Phase, Power Density, Power Spectrum, Real, Real + Imaginary.

with

Selects the FFT window type: Rectangular, Hanning, Hamming, Blackman-Harris, Flat-top.

of

Selects the source trace.

FFT INTERRUPTION (ABORT)

During FFT computation the symbol FFT is displayed in the lower right-hand corner of the screen). Since the computation of FFT on long time-domain records may take a long time, it is possible to interrupt an FFT computation with any front-panel button or knob.

SETUP MENU FOR
FFT AVERAGE

This menu is used to display the FFT power averaging of an FFT source trace.

Power averaging is useful for the characterization of broadband noise or of periodic signals for which a stable trigger signal is not available. Note that this type of averaging measures the total power (signal and noise) at each frequency.

Note: The source trace must be an FFT function.

Setup of A
use Math? No Yes
Math Type Enh. Res Extrema FFT FFTAVG Functions
FFT result Magnitude Power Dens Power Spect
for 1000 (sweeps)
of B C D

use Math?

Select Yes.

Math Type

Select FFT AVG.

FFT result

Selects the output format of the FFT Average: Magnitude, Power Density, Power Spectrum.

for

Selects the number of sweeps desired for the operation.

of

Selects the FFT source.

The FFT AVERAGE can be reset by pushing the CLEAR SWEEPS button. The number of currently accumulated waveforms is displayed in the Displayed Trace field of the function or its expansion.

ZOOM + MATH

SETUP MENU FOR
FUNCTIONS

This menu is used to display any of the following functions:

Absolute value	Log (base e)
Derivative	Log 10 (base 10)
Exp (base e)	Negation
Exp 10 (base 10)	Reciprocal
Identity	Sinx/x
Integral	Square
	Square root

Notes:

Square Root is actually computed on the absolute value of the source waveform.

For logarithmic and exponential functions the numerical value (without units) of the input waveform is used.

For the integral function the source waveform may be offset by an Additive Constant in the range -10^{16} to $+10^{16}$ times the vertical unit of the source waveform.

SETUP OF A

use Math?
No **Yes**

Math Type
Extrema
FFT
FFTAvg
Functions
Rescale

Function
Negation
Reciprocal
SIN
Square
Square Root

of

1 2 3 4 B C D
M1 M2 M3 M4

use Math?
Select Yes.

Math Type
Select Functions.

Function
Selects the function type.

of
Selects the source trace.

ZOOM + MATH

SETUP MENU FOR RESCALE

This menu is used to select a waveform and adjust the multiplication factor a and the additive constant b in:

$$(a * \text{waveform}) + b$$

Both constants can have values between -10^{15} and $+10^{15}$.

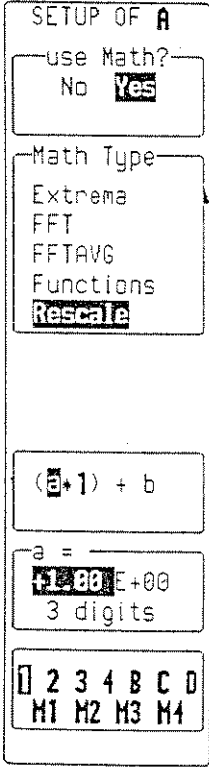

use Math?

Select Yes.

Math Type

Select Rescale.

Use the button next to $(a * 1) + b$ to highlight either a or b.

a = (or b =)

Use this button to highlight the mantissa, the exponent, or the number of digits.

Use the knob to change the highlighted value.

The last box on the menu allows selection of the source waveform to be rescaled.

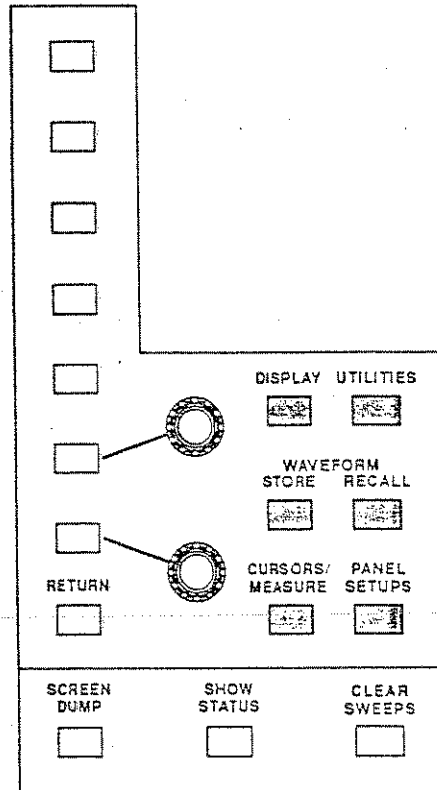
**MENU BUTTONS**

When a menu is activated by pressing one of the dark-grey menu-entry keys on the front panel, up to seven fields appear on the right-hand side of the display. These fields can be controlled by using one of the seven menu buttons.

The eighth (bottom) button marked RETURN is used to go back to a higher-level menu, or – when at the highest possible level – to switch the menu off.

MENU KNOBS

The two menu knobs are associated with the last two menu fields. Both the button and the adjacent knob provide control of the field. For example, the button may be used to step through a list of parameters and the knob used to set the selected parameter's value.

MENU CONTROLS

- DISPLAY** This button calls up the DISPLAY menu, described in Chapter 18, which controls grids, intensities, persistence modes, etc.
- UTILITIES** This button calls up the UTILITIES menu, described in Chapter 19, which controls printer setups, GPIB addresses, etc.
- WAVEFORM STORE** This button calls up the WAVEFORM STORE menu, described in Chapter 20, which is used to store waveforms to internal memory or external memory.
- WAVEFORM RECALL** This button calls up the WAVEFORM RECALL menu, described in Chapter 21, which is used to retrieve waveforms stored on cards or floppy disks.
- CURSORS/MEASURE** This button calls up the CURSORS/MEASURE menu, described in Chapter 22, for precise cursor and parameter measurements on traces.
- PANEL SETUPS** This button calls up the PANEL SETUPS menu, described in Chapter 23, which is used to save or recall a configuration of the instrument.
- SCREEN DUMP** Causes a print or plot of the current screen display to an on-line hardcopy device, via the oscilloscope's GPIB or RS-232-C interface ports. All the screen illustrations included in this manual were produced using the Screen Dump function.
- Once the SCREEN DUMP button has been pressed, *all* the displayed information will be copied. It is possible to copy the waveforms without also copying the grid, by turning the grid intensity down to 0 in the Display Setup menu.
- While a screen dump is taking place, as indicated by the PRINTING or PLOTTING message on the lower right part of the screen, it can be aborted by pressing the SCREEN DUMP button a second time. Allow some time for the buffer to empty before copying stops.
- Note: See Chapter 19 UTILITIES for HARDCOPY SETUP.*
- CLEAR SWEEPS** Many operations require several acquisitions (referred to as sweeps), among which are averaging (see Chapter 16 for description of AVERAGE menu), persistence, and pass/fail testing. The CLEAR SWEEPS button "restarts" these operations by resetting the sweep counter(s) to zero.

**GENERAL INSTRUMENT
RESET**

To reset the instrument, simultaneously press the AUTO SETUP button, the top menu-button, and the RETURN button. The instrument will revert to its default power-up settings.

The Display menu is used to select:

- Standard or XY mode
- Persistence OFF or ON
- The number of grids on screen
- The intensity adjustments for the waveforms and text
- The intensity adjustments for the grids

Standard Display vs XY Display

The standard display allows the presentation of source waveforms versus time (or versus frequency for FFTs).

The XY display allows the presentation of one source waveform versus another.

The XY display can be generated if the traces selected have the same time or frequency span (same T/div) and have the same horizontal unit (second or Hertz). As soon as two compatible traces are selected, the XY display is automatically generated. If incompatible traces are selected, a warning message is displayed at the top of the screen. If the two compatible traces are not matched in time, their XY diagram will still be displayed with an indication of the shifting – in time or in frequency – between the two traces. The ΔT or Δf indicator is displayed in the displayed trace field on the left of the screen.

MENU CONTROLS

Persistence

In Persistence Display – available in both Standard and XY mode – the oscilloscope can display points so that they accumulate on screen over many acquisitions. “Eye diagrams” and “Constellation displays” can be achieved using this display mode. The most recent sweep is displayed as a “vector” trace over the persistence display. This feature, however, is not available in XY or in Sequence mode.

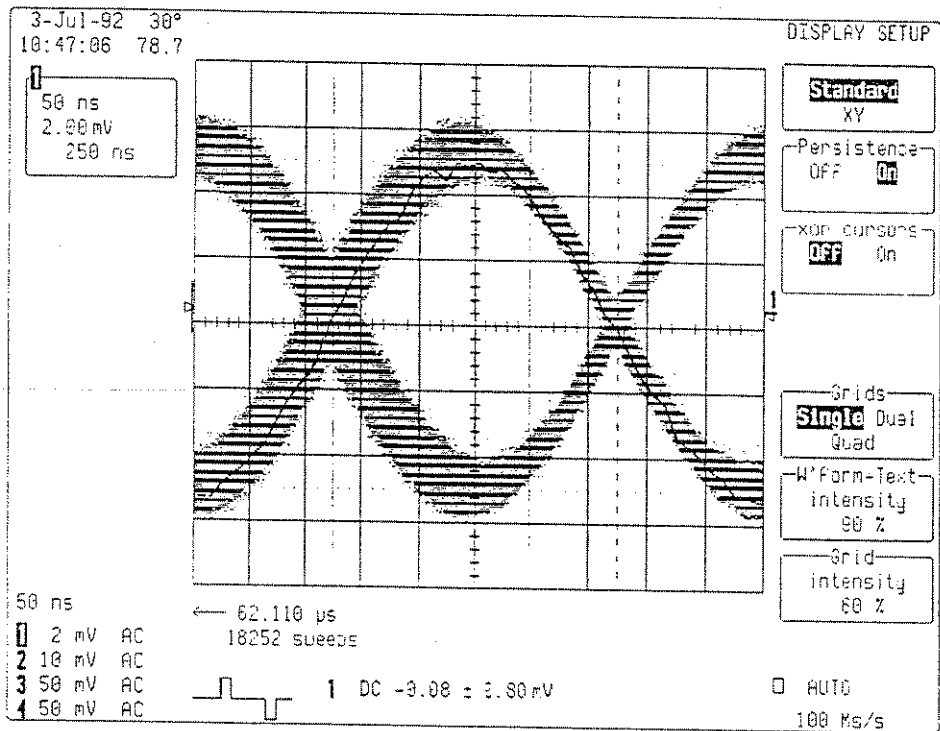

Screen Presentation

Grid sizes and presentations depend on whether the instrument is in Standard or in XY display.

The "Parameter" display can only be chosen in Standard display with persistence OFF, by accessing the CURSORS/MEASURE menu and selecting parameters or PASS/FAIL. In "Parameter" display, only single grid presentation is available.

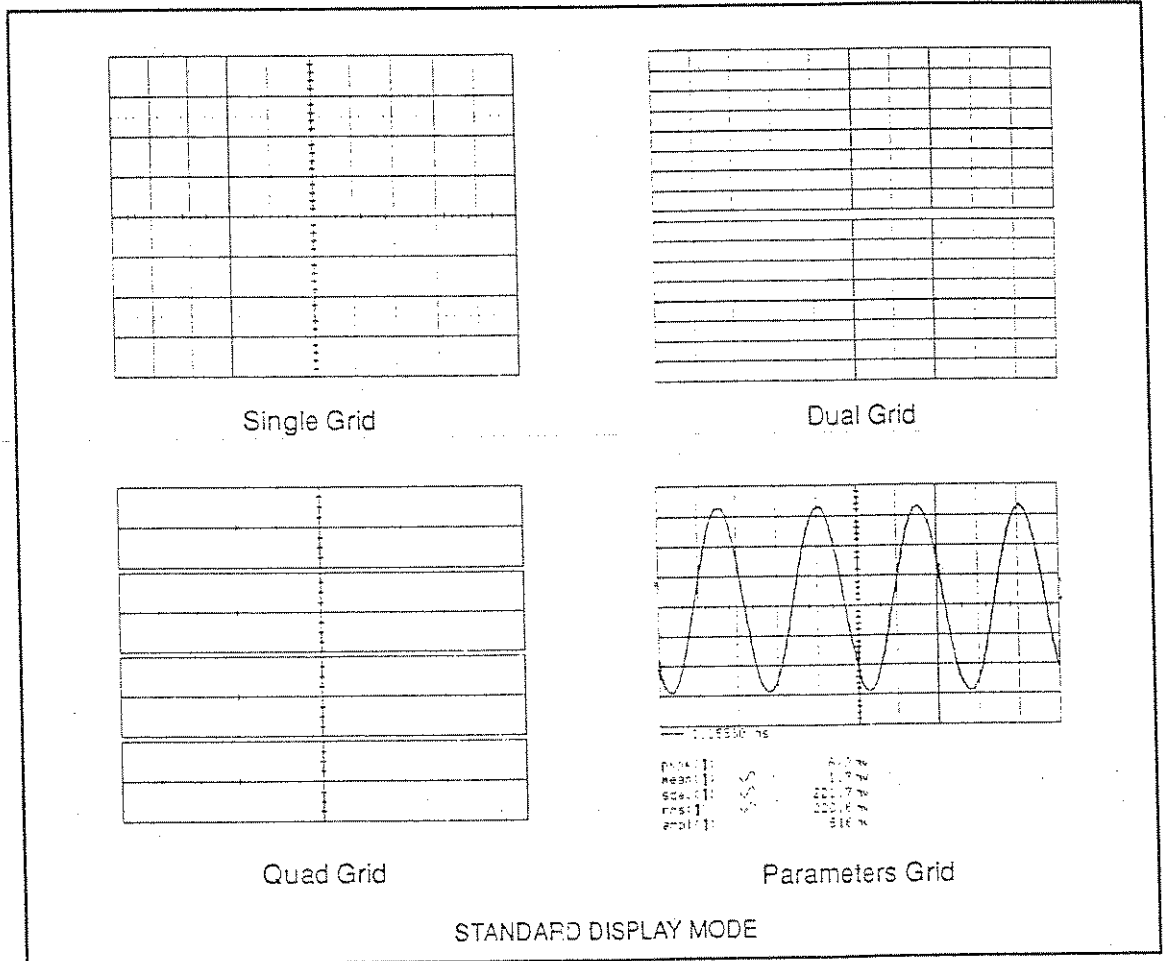

MENU CONTROLS

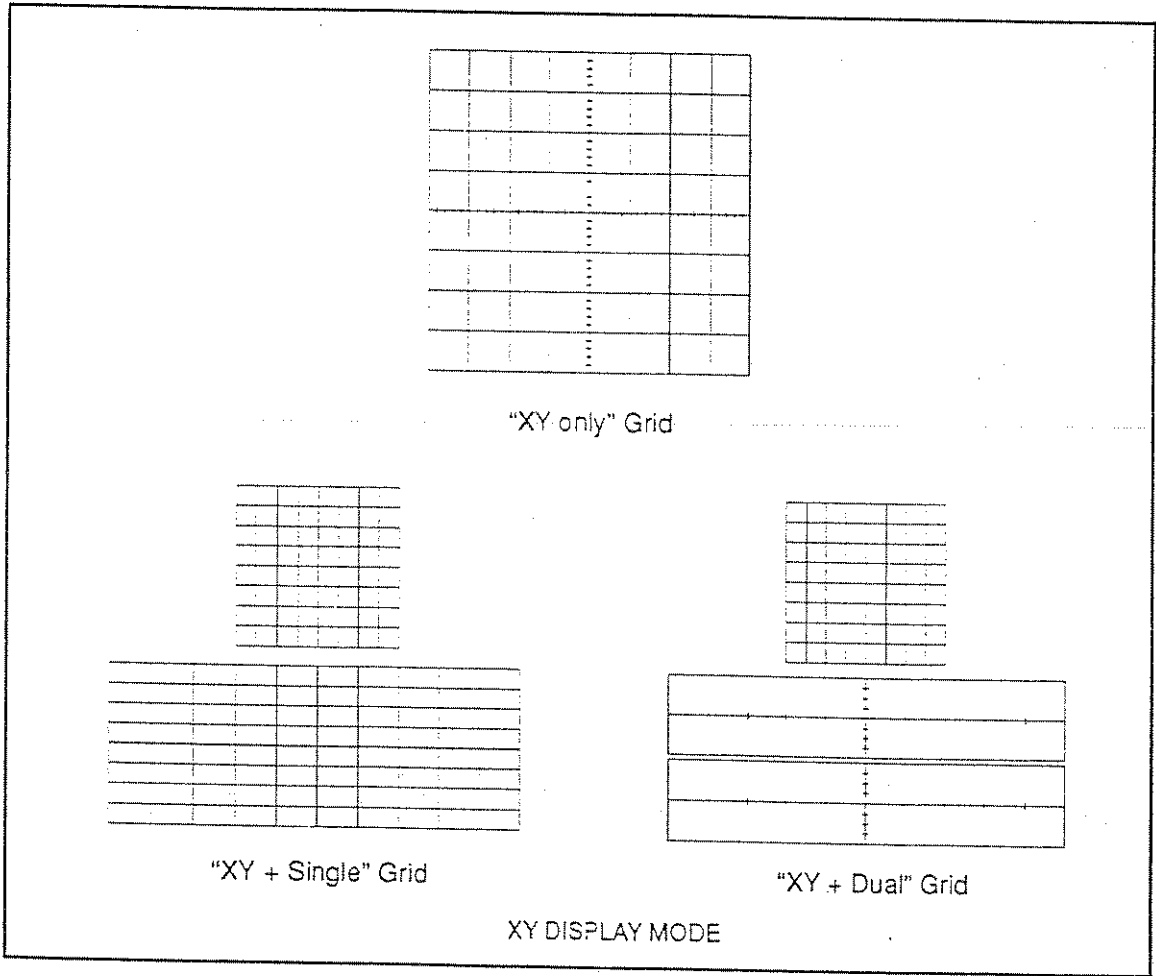

STANDARD DISPLAY

DISPLAY SETUP	
Standard	XY
Persistence	OFF On
Grids	Single Dual Quad
W'form+Text intensity	90 %
Grid intensity	60 %

Persistence

Selects the persistence mode. When set to ON, can be cleared and reset by pressing the CLEAR SWEEPS button or by changing any acquisition condition, any waveform processing condition, or the number of grids.

Grids

Selects the desired number of grids. If the "Parameters" or the "PASS/FAIL" mode is selected in the CURSORS/MEASURE menu, then only the single grid is available.

W'form + Text intensity

Adjusts the screen intensity for waveforms and text, using the attributed menu knob.

Grid intensity

Adjusts the screen intensity for grids, using the attributed menu knob. If the grid intensity is turned down to 0, the grids will not show on a screen dump.

XY DISPLAY

DISPLAY SETUP	
Standard	XY
Persistence	OFF On
Grids	XY only
Single Dual	
W'form+Text	intensity
	90 %
Grid	intensity
	60 %

Persistence

Selects the persistence mode. When set to ON, can be cleared and reset by pressing the CLEAR SWEEPS button or by changing any acquisition condition, any waveform processing condition, or the number of grids. The number of sweeps accumulated (up to 1000000) is displayed below the grid. Persistence is not available for traces with more than 50000 points (L models only).

Grids

Selects the desired number of grids. In "XY only" mode, the XY grid occupies the maximum possible space on screen. In Single Grid, a smaller square grid is used for the XY display while the rectangular grid underneath simultaneously shows the original source waveforms. The rectangular grid can also be used in a dual grid mode by selecting Dual Grid.

W'form + Text intensity

Adjusts the screen intensity for waveforms and text, using the attributed menu knob.

Grid intensity

Adjusts the screen intensity for grids, using the attributed menu knob. If the grid intensity is turned down to 0, the grids will not show on a screen dump.

This section describes the Utilities menu which is used to select:

- The hardcopy settings
- The time and date settings for the real-time clock
- The GPIB and RS232 settings
- The memory card or floppy disk utilities (copy and format, delete files...)
- The Special Modes of operation (offset behavior, sequence time-out)
- The function of the signal at the CAL BNC connector (magnitude, frequency, shape, trigger out, pass/fail use).

UTILITIES MAIN MENU

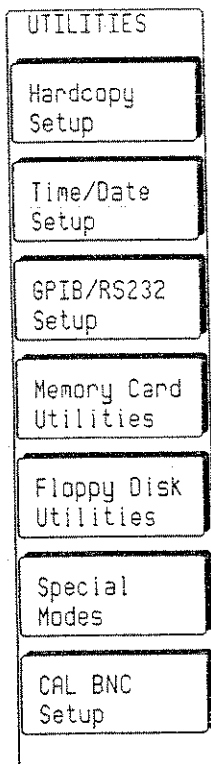

Hardcopy Setup

Press this button to view/change the current printer or plotter settings.

Time/Date Setup

Press this button to adjust the real-time clock displayed in the upper left corner of the screen.

GPIB/RS232 Setup

Press this button to view/change the current interface settings.

Memory Card Utilities

Press this button to access the Memory Card Utilities menu.

Floppy Disk Utilities

Press this button to access the Floppy Disk Utilities menu.

Special Modes

Press this button to access the Special Modes menu.

CAL BNC Setup

Press this button to access the CAL BNC menu. This button only appears in instruments with the CLBZ hardware option.

MENU CONTROLS

HARDCOPY SETUP MENU

HARDCOPY	
output to	Card Floppy GPiB RS232 Centronics
page feed	OFF On
plotter	LaserJet ThinkJet TIFF HP 7470 HP 7550
plot size	A5 (8.5"/5.5") A4 (11"/8.5")
pen number	2

output to

Selects the device to which the instrument should output. If using a port, check the GPIB & RS232 menu to make sure that the settings are correct.

The device can be either a port (RS232, GPIB, Centronics) to which a plotter or printer is connected, a storage unit (card, floppy), or the internal printer. The list of devices shows the options installed in the instrument.

When copying to a storage unit, a file name will be assigned automatically, following the rules set out in the file-naming section.

page feed

Select On to start on a new page each time the SCREEN DUMP button is pressed.

plotter/printer protocol

Use the menu buttons to select the appropriate driver.

Note: Press the SCREEN DUMP button on the front panel to make a copy of the current screen display.

plot size (for plotters only)

Selects the desired size: A4 (11" x 8.5"), A5 (8.5" x 5.5").

pen number (for plotters only)

Selects the number of pens installed on the plotter. The oscilloscope assumes the pens are loaded consecutively in the lower slots.

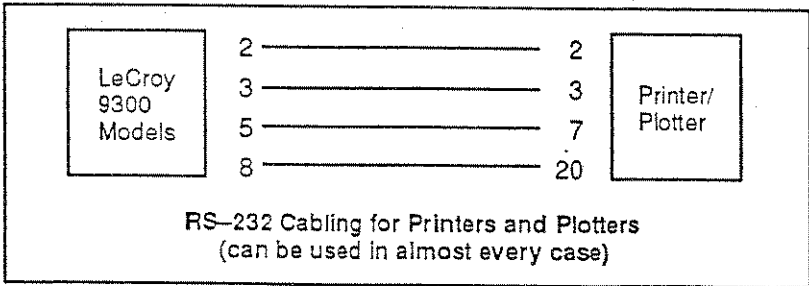

INTERNAL PRINTER SETUP MENU

HARDCOPY

output to

Int. Printer
Card
Floppy
GPIB
RS232

cm/division

1	2
10	10
20	50
100	200

output to
Select Internal Printer.

cm/division
Select the appropriate expansion factor.
Note: When the expansion factor is greater than 1, neither persistence nor cursors can be obtained on the hardcopy.

MENU CONTROLS

TIME/DATE MENU

TIME/DATE

SET CLOCK FORWARD ONE HOUR (SPRING)

SET CLOCK BACKWARD ONE HOUR (FALL)

LOAD CHANGES NOW

Hour Min Sec
15:04:04

Day Mnth Year
4 DEC 1991

SET CLOCK...(SPRING)
Press this button to switch to summer time.

SET CLOCK...(FALL)
Press this button to switch to winter time.

LOAD CHANGES NOW
Activates the changes made with the "Hour/Min/Sec" and "Day/Month/Year" buttons and knobs.

Hour/Min/Sec
Press the menu button to toggle between "hour", "minutes", and "seconds". Use the menu knob to adjust the corresponding value.

Day/Mnth/Year
Press the menu button to toggle between "day", "month", and "year". Use the menu knob to adjust the corresponding value.

GPIB & RS232 MENU

GPIB & RS232	
Remote Control from	GPIB RS232
RS232 Mode	7-bit 8-bit
Parity	none odd even
Stop bits	1 2
Baud Rate	300 1200 2400 4800 9600 19200
GPIB Device (Address)	4

Remote Control from

Selects the port for remote control.

Note: When RS-232 is selected, the GPIB interface is in "Talk Only" mode.

RS232 Mode

Selects 7-bit or 8-bit mode for RS-232 communication.

Parity

Selects the parity for RS-232 communication.

Stop bits

Selects the number of stop bits for RS-232 communication.

Baud Rate

Selects the appropriate baud rate, using the attributed menu knob.

GPIB Device (Address)

Selects the appropriate GPIB address.

Note: Any change becomes immediately effective.

MENU CONTROLS

RS-232-C CONNECTOR

The RS-232-C port on the rear panel can be used for remote oscilloscope operation, as well as for direct interfacing of the oscilloscope to a hardcopy device to produce copies of displayed waveforms and other screen data.

While a printer or plotter unit is connected to the oscilloscope, its RS-232-C port can be computer controlled from a host computer via the GPIB port. The oscilloscope's built-in drivers allow hard copies to be made without an external computer.

RS-232-C connector pin assignments:

DB9 Pin #		Description
3	T × D	Transmitted data (from the oscilloscope).
2	R × D	Received data (to the oscilloscope).
7	RTS	Request to send (from the oscilloscope). If the software Xon/Xoff handshake is selected it is always TRUE. Otherwise (hardware handshake) it is TRUE when the oscilloscope is able to receive characters and FALSE when the oscilloscope is unable to receive characters.
8	CTS	Clear to send (to the oscilloscope). When true, the oscilloscope can transmit; when false, transmission stops. It is used for the oscilloscope output hardware handshake.
4	DTR	Data terminal ready (from oscilloscope). Always TRUE.
—	GND	Protective Ground.
5	SIG GND	Signal Ground.

This corresponds to a DTE (Data Terminal Equipment) configuration.

MEMORY CARD UTILITIES MENU (optional)

This menu displays information about the memory card loaded into the oscilloscope:

- Last "format" date and time
- Memory size and available free space
- Date, time and size information of the selected file on the card (highlighted in the bottom menu-field)

In addition, this menu provides access to the following operations:

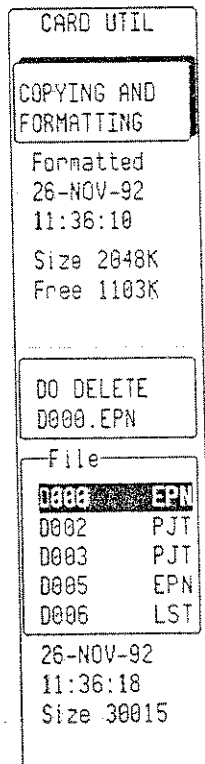

COPYING AND FORMATTING

Select this menu to format the card or to copy the machine template to the card. The template is an ASCII text-file which contains all the information required to decode the descriptor part of a binary waveform.

DO DELETE

Deletes the file selected at the bottom of the menu.

File

Selects the file to be deleted, using the attributed menu knob or buttons.

Note: When the instrument is equipped with both the memory card (MC01) and the floppy disk ((FP01) options, a "File Transfers" sub-menu appears, allowing file transfers between the storage media (see page 19-13).

MEMORY CARD AND FLOPPY DISK STRUCTURE

MC Format

The Memory Card's structure, based on the PCMCIA 1.0/JEIDA 4.0 standard, consists of a DOS partition containing files as in any DOS floppy or hard disk.

When the card is formatted by the oscilloscope it is segmented in contiguous sectors of 512 bytes each. The oscilloscope does not support error detection algorithms such as CRC's or checksum that are inserted between the sectors. In this case, the oscilloscope may still be able to read the card but be unable to write to the card.

Floppy Disk Format

The floppy disk supports DOS 1.44 Mb and 720 Kb formats.

LeCroy Subdirectory

All the files are written to the media in a subdirectory called LECROY_1.DIR. This directory is automatically created when the media is formatted. If the media has been formatted elsewhere – for instance in a PC – the directory will be created the first time a file is stored to the memory card or to the floppy disk.

File-naming Structure

As in MS-DOS, the file name can take up to 8 characters followed by an extension of 3 characters.

A file is treated as:

- a Panel setup if its extension is PNL.
- a Waveform if its extension is a 3-digit number.
- a Waveform Template if its extension is TPL.
- a Hardcopy if its extension is TIF, PRT or PLT.

If the file you are storing carries the same name as a file already on the media, the old file will be deleted.

When the instrument stores a file, it automatically generates predefined filenames as follows:

- Panels: **Pnnn.PNL**. nnn denotes a 3-digit decimal sequence number. The first panel saved on the media will be P001.PNL, the second will be P002.PNL, etc.
- Waveform: **Axx.nnn** or **Sxx.nnn**. xx defines the trace name:
 - C1, C2, C3, C4 for Channel 1, Channel 2, Channel 3, Channel 4 traces.
 - TA, TB, TC, TD for functions

The file's first letter A stands for an autostored file, while S stands for an individually stored file. Files from a computer should not be

given names beginning with an "A" character as this could cause them to be overwritten by an Autostore routine.

nnn denotes a 3-digit decimal sequence number. The first "Channel 1" waveform stored to the media will be SC1.001, the second will be SC1.002, etc.

- Descriptor Template: **LECROYxx.TPL**. xx stands for the version of the template. If the version is 2.1 for example, the template file will be saved as **LECROY21.TPL**.
- Hardcopy: **Dxxx.TIF** if the hardcopy is set to TIF, **Dxxx.PRT** if the hardcopy is set to any selection of printers, **Dxxx.PLT** if the hardcopy is set to any selection of plotters.

More on Autostored Files

If the "Fill" option is selected, the first waveform stored will be Axx.001, the second Axx.002, and so on until the media is full or until the file number reaches 999.

If the "Wrap" option is selected, the oldest autostored waveform files will be deleted whenever the media becomes full. Remaining autostored waveform files are renamed, the oldest group of files being named "Axx.001", the second oldest "Axx.002", etc.

Write Protect Switch

At the back of the memory card or the floppy disk you will find a write protection switch that may be activated to prevent writing to the card or disk. A "Device is Write Protected" message will then be displayed on the upper part of the grid whenever the media is accessed for writing.

Battery

Every SRAM memory card contains a small battery to preserve the data. It is a button-size type BC2325 or CR2325 battery and it can be changed when necessary. The oscilloscope will warn you with a "BAD BATTERY" message that the battery has to be changed. To access the battery, remove the small lid on the upper edge of the card. The battery can be changed even when the memory card is still installed in the oscilloscope. In fact, it should be changed *while* it is inserted in the oscilloscope in order to prevent loss of information on the card while it is temporarily without a battery.

MENU CONTROLS

FLOPPY DISK UTILITIES MENU (optional)

This menu displays information about the floppy disk installed in the oscilloscope:

- Last "format" date and time
- Media size and available free space
- Date, time and size information of the selected file on the floppy disk (highlighted in the bottom menu-field)

In addition, this menu provides access to the following operations:

DISK UTIL

COPYING AND FORMATTING

Formatted
26-NOV-92
11:19:28
Size 1440K
Free 790K

DO DELETE
D000.EPN

File

D000	EPN
D001	EPN
D002	PJT
D003	PJT
D004	LST

26-NOV-92
11:19:56
Size 30023

COPYING AND FORMATTING

Select this menu to format the disk or to copy the machine template to the disk. The template is an ASCII text-file which contains all the information required to decode the descriptor part of a binary waveform.

DO DELETE

Deletes the file selected in the box below.

File

Selects the file to be deleted, using the attributed menu knob or buttons.

This menu appears every time a disk operation is required:

- if a new disk is inserted in the drive.
- if no disk is present in the drive.

DISPLAY NEW FLOPPY

Reads the disk and displays the contents of the directory.

DISK UTIL

DISPLAY
NEW FLOPPY

Please
insert Floppy

+ push menu
button above

MENU CONTROLS

FORMAT DISK
! FORMATTING ERASES ALL INFO ON DISK
PERFORM DISK FORMAT
Density
1.44 MB (HD) 720 KB (DD)
COPY TEMPLATE TO DISK
REORDER ALL FILES BY DATE
File Transfers

PERFORM DISK FORMAT

Formats the floppy disk with a density of 1.44 Mb or 720 Kb, selectable in the box below. The disk will have a DOS format, with an interleave factor of 2 to optimize throughput to and from the oscilloscope.

Density

Select density desired – 1.44 Mb (HD) or 720 Kb (DD).

COPY TEMPLATE TO DISK

Copies the machine template to the disk. The template is an ASCII text-file which contains all the information required to decode the descriptor part of a binary waveform.

REORDER ALL FILES BY DATE

Reorders the disk so that the directory listing shows the files sorted by date.

File Transfers

This menu field appears when the instrument is equipped with both the memory card (MC01) and the floppy disk (FP01) options, and allows file transfers between the two storage media.

COPY FILES

Direction

Card -> Disk

Disk -> Card

Which files

Panels

Prints

Auto Wfms

Norm Wfms

All Files

DO COPY

!OVERWRITES
FILES WITH
SAME NAME

Direction

Select the copy source → destination.

Which files

Choose the file types to be copied.

DO COPY

Copies the selected files.

MENU CONTROLS

SPECIAL MODES MENU

SPECIAL MODES
On GAIN
changes, all
OFFSETS Fixed

in
Volts
Divisions

AUTO sequence
times out
100.0000 s
after last
segment

In
Specifies the offset behavior on a gain (VOLTS/DIV) change. The offset can be fixed either in Volts or in vertical Divisions.

AUTO sequence
Specifies the time-out in Sequence mode (see Chapter 8). Use the associated menu knob to change the value.

CAL BNC OUT MENU

The type of signal put out at the CAL BNC connector can be controlled from this menu. It is used to select:

- The frequency of the calibration signal (CLBZ hardware option)
- The amplitude of the calibration signal (CLBZ hardware option)
- The pulse shape for the calibration signal (CLBZ hardware option)

Furthermore, with the CKIO software option, the CAL BNC connector can be used to provide a pulse:

- at the occurrence of each trigger
- as an action for PASS/FAIL testing

Note that when the instrument is turned on, the calibration signal is automatically set to its default state (1kHz 1V square wave).

The menu is shown here as it appears for an instrument with the CKIO software option.

CAL BNC OUT

mode

CAL signal

OFF

Pass/Fail

Trigger Out

SET TO 1 KHz
1 V SQUARE

Shape

Square

Pulse(25 ns)

Amplitude

1.00 V

into 1 MΩ

Frequency

1 KHz

mode

Press this button to change the kind of signal made available.

SET TO

Press this button to quickly reset the CAL BNC output to its default state.

Shape

Press this button to change the form of the calibration signal.

Amplitude

Use the knob to set the desired high level for all uses of the CAL BNC.

Frequency

Use the knob to set the desired frequency of a CAL signal in the range 500 Hz to 2 MHz.



The Waveform Store menu is used to select:

- The waveform(s) to be stored to internal memory, to the memory card (optional), or to the floppy disk (optional);
- Automatic storage to the memory card (Auto-store) (optional), or to the floppy disk (optional).
- Auto-store mode: stop when media is full or "wraparound" as in a circular buffer (optional).

STORE W'FORMS			
Size 1440K Free 770K			
Auto-Store			
<input checked="" type="checkbox"/> OFF			
Wrap Fill			
DO STORE			
(<4->Disk)			
store			
1	2		
3	<input checked="" type="checkbox"/>		
A	B		
C	D		
All displayed			
to			
M1	M2	M3	M4
Card		<input checked="" type="checkbox"/> DISK	

Auto-Store

Appears only when storage to memory card or floppy disk is selected in bottom menu box. Select **Auto-Store** to automatically store waveforms after each acquisition.

Two kinds of Autostore mode can be selected: **Fill** stores acquired waveforms until the media becomes full, and **Wrap** stores continuously to the media, discarding the oldest autostored files in a first-in-first-out manner.

DO STORE

Use this menu button to perform the STORE operation based on the instructions given in the two following menu boxes.

store

Selects the waveform to be stored. "All displayed" will automatically select storage to the memory card (see below).

to

Selects either one of the internal memories (M1 to M4), the memory card (optional), or the floppy disk (optional).

The Recall Waveform menu is used to recall a waveform from one of the internal memories, from the memory card (optional), or from the floppy disk (optional).

RECALLING FROM AN INTERNAL MEMORY

RECALL W'FORM	
From	Memories
	Card Disk
DO RECALL	
M2 -> B	
From Memory	M1
	<input checked="" type="checkbox"/> M2
	M3
	M4
to	A B C D

from
Select Memories.

DO RECALL

This menu button is used to perform the RECALL operation based on the instructions given in the two following menu boxes. At the same time, the horizontal and vertical positions and zooms are reset to show the full contents of the memory at its original magnification.

from Memory
Selects source memory.

to
Selects the destination trace.

Note: Performing a recall operation from an internal memory to a trace A...D overrides any previous definition of the destination trace. (See chapter 14, Zoom + Math Capabilities).

MENU CONTROLS

RECALLING FROM A MEMORY CARD OR FLOPPY DISK

RECALL W' FORM

from
Memories
Card **DISK**

27-NOV-92
10:00:42
Size 409

DO RECALL
SC2.001

File

SC1	000
SC2	001
SC2	002
SC3	003
SC4	004

to
M1 M2 **M3** M4

from
Select Card or Disk.

DO RECALL
This menu button is used to perform the RECALL operation, based on the instructions given in the two following menu boxes.

File
Selects the waveform file, using the attributed menu knob.

to
Selects the destination memory.

CURSORS IN STANDARD DISPLAY

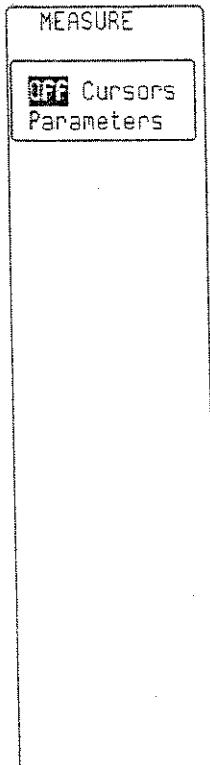

Cursors provide basic tools for measuring signal values. Vertical cursors can be moved in steps as small as 1/64 of a division to measure signal amplitudes with 0.2% resolution. Horizontal cursors can be placed at a desired time to read the amplitude of a signal at that time, and can be displaced in time with a resolution of 2000 steps across the grid width (0.05% of the entire displayed time span).

In Absolute mode, one cursor can be manipulated and amplitude, or time and amplitude, readings are provided. Amplitudes relate to ground, and times relate to trigger times.

In Relative mode, two cursors can be manipulated, providing readings of the difference in amplitude, or time and amplitude, between the two cursors.

Amplitudes are always shown in the trace label field for each trace. For horizontal cursors, the time is shown below the grid. In Relative mode, the frequency corresponding to the time interval between the two cursors is also displayed here. When the horizontal scale implies that less than 500 digitized points fill the screen, the oscilloscope interpolates, using straight line segments between actual data points. If 200 points or less are used, the digitized points are clearly visible as intensified points on the screen. When a cursor is placed on an actual data point, horizontal bars appear on the cursor.

When there are more than 500 digitized points, the trace is displayed on the screen with a resolution of 500 display points. A compacting algorithm showing all minimum and maximum values ensures that no information is lost when a trace is displayed. Time cursors can be positioned on any one of the 500 display points of a compacted trace.

Note that setting the cross-hair marker to 0 time provides a visual indication of the trigger point.

CURSORS IN PERSISTENCE DISPLAY

Voltage cursors are similar to those in standard display mode. Time cursors consist of vertical bars which are placed on the desired part of the displayed waveform.

CURSORS IN XY DISPLAY

As in the standard display, time and voltage cursors can be used in the XY display.

Absolute voltage cursors show as a vertical and a horizontal bar.

Relative voltage cursors show as a pair of vertical and a pair of horizontal bars.

MENU CONTROLS

Absolute and relative time cursors are similar to those in standard display mode.

Combinations of the vertical values (voltages) are shown on the left side of the square grid):

- (1) The ratio ΔY value / ΔX value
- (2) The ratio in dB units $20 \cdot \log_{10}(\text{ratio})$
- (3) The product ΔY value * ΔX value
- (4) The distance to the origin $r = \text{sqrt}(\Delta X^2 + \Delta Y^2)$
- (5) The angle (polar) $\phi = \text{arc tan}(\Delta Y / \Delta X)$
range $[-180^\circ \text{ to } +180^\circ]$.

The definition of ΔX and ΔY is dependent on the type of cursors used. The following table shows how ΔX and ΔY are defined for each type of measurement.

Cursors					
	V_{Abs}	V_{Rel}	T_{Abs}		T_{Rel}
			Org = (0,0)	Org = $V_{XOffset}$ $V_{YOffset}$	
ΔX	$V_{XRef} - 0$	$V_{XDif} - V_{XRef}$	$V_{XRef} - 0$	$V_{XRef} - V_{XOffset}$	$V_{XDif} - V_{XRef}$
ΔY	$V_{YRef} - 0$	$V_{YDif} - V_{YRef}$	$V_{YRef} - 0$	$V_{YRef} - V_{YOffset}$	$V_{YDif} - V_{YRef}$

Where

V_{Abs} = Absolute Voltage cursors

V_{Rel} = Relative Voltage cursors

T_{Abs} = Absolute Time cursors

T_{Rel} = Relative Time cursors

Org = Origin

V_{XRef} = Voltage of the reference cursor on the X trace

V_{YRef} = Voltage of the reference cursor on the Y trace

V_{XDif} = Voltage of the difference cursor on the X trace

V_{YDif} = Voltage of the difference cursor on the Y trace

AUTOMATIC MEASUREMENTS

Certain signal properties can be determined automatically, using a parameter measurement mode. The following table lists all the parameters that can be determined by the instrument. Appendix D describes the methods employed to determine these parameters.

Statistical variations of these signal parameters over several successively captured signals can be observed as average, standard, and extreme deviations.

PASS/FAIL









Pass/Fail tests can be performed using these parameter measurements. These tests require a combination of parameter measurements to be within chosen limits, and provoke an action if the test either passes or fails. Alternatively, the pass/fail test can be a test of a signal against a tolerance mask.

MENU CONTROLS

PARAMETER	ABBREV.	EXPLANATION
amplitude	ampl	Absolute value of the top minus the base.
area	area	Sum of sampled values between the cursors times the duration of a sample.
base	base	First of two most probable states. This is characteristic of rectangular waveforms and represents the first most probable state determined from the statistical distribution of data point values in the waveform.
cycles	cycles	Number of pairs of transitions in the same direction.
delay	delay	Time from trigger to the midpoint of the first transition.
duty cycle	duty	Width as a percentage of period.
fall time	fall	Duration of the pulse waveform's falling transition from 90% to 10%, averaged for all falling transitions between the cursors.
first	first	Time from trigger to first (leftmost) cursor.
frequency	freq	Reciprocal of period.
last	last	Time from trigger to last (rightmost) cursor.
maximum	maximum	Maximum value of the trace between the cursors.
mean	mean	Average or DC level of the waveform. If the waveform is periodic, it is computed over an integral number of periods.
median	median	The average of base and top values.
minimum	minimum	Minimum value of the trace between the cursors.
overshoot negative	oversh-	Lower most probable value minus the minimum sample value, expressed as a percentage of the amplitude.
overshoot positive	oversh+	Maximum sample value minus the higher most probable value, expressed as a percentage of the amplitude.
peak-to-peak	pkpk	Difference between the maximum and the minimum values.
period	period	Time of a full cycle averaged for all full cycles between the cursors.
points	points	Number of points between the vertical cursors.
rise time	rise	Duration of the pulse waveform's rising transition from 10% to 90%, averaged for all rising transitions between the cursors.
root mean square	rms	Square root of sum of squares, divided by number of terms. If waveform is periodic, it is computed over an integral number of periods.
standard deviation	sdev	Square root of sum of squares of difference from mean, divided by number of terms. If the waveform is periodic, it is computed over an integral number of periods.
top	top	Second of two most probable states. Characteristic of rectangular waveforms and represents the second most probable state determined from the statistical distribution of data point values in the waveform.
width	width	Width of the first pulse (either positive or negative), averaged for all similar pulses between the cursors.

PARAMETER INFORMATION AND WARNING SYMBOLS

The algorithms which determine the pulse waveform parameters are capable of detecting certain situations where the mathematical formulas may be applied but the results obtained must be interpreted with caution. In these cases, the name of the parameter and its value are separated on the screen by a graphic symbol. The symbols and their meanings are indicated in the figure below .

INFORMATION	
	Parameter has been determined for several periods (up to 100), and the average of those values has been taken
	Parameter has been determined over an integral number of periods
	Insufficient data to determine a parameter.
WARNINGS	
	i.e., amplitude histogram is flat within statistical fluctuations. Minimum and maximum are used to assign base and top.
	Only an upper limit could be estimated (actual value of parameter may be smaller than displayed value)
	Signal is partially in overflow.
	Signal is partially in underflow.
	Signal is partially in overflow and partially in underflow.

MENU CONTROLS

CURSORS MENU

MEASURE
OFF Cursors Parameters
mode Time Amplitude
type Relative Absolute
Reference cursor Track OFF On
Difference cursor

Off/Cursors/Parameters

Select **Cursors**.

mode

Selects **Time** (time or frequency) or **Amplitude** (voltage or amplitude) cursors.

type

Toggles between **Relative** and **Absolute**. **Relative** displays two cursors – reference and difference – and indicates either the voltage or the time and voltage between the two cursors. **Absolute** displays one cursor that indicates either a voltage compared to the ground level, or a time compared to the trigger point and a voltage compared to the ground level.

Origin at (XY mode only)

In order to make the polar readout of the absolute time cursor more useful, there is the possibility of choosing between two reference points. The reference is either located at point (0, 0), i.e. at X = 0 Volt and Y = 0 Volt, or at the center of the square grid. This menu button, active only in absolute time cursor mode, toggles the position of the reference origin between the center of the grid and (0,0).

The values of the origin are displayed on the left-hand side of the square grid. By changing the offsets of the source traces the user can center a figure on the screen and then measure angles and distances with respect to the center of the figure.

Reference cursor

Available with the **Relative** type cursors. The corresponding menu knob controls the Reference cursor.

When **Track** is ON, both Reference and Difference cursors are controlled by this knob and move together, keeping a constant time or voltage interval between them. This tracking interval is represented by a bar (horizontal for time, vertical for voltage) that appears either on the top (time) or on the left (voltage) edge of the grid.

Difference cursor

Available with the **Relative** type cursors. The corresponding menu knob controls the Difference cursor.

Cursor position

Available with the **Absolute** type cursors. The corresponding menu knob controls the cursor.

PARAMETERS MENU

Parameters can be measured in two standard classes, making commonly needed measurements on a single signal in either the amplitude domain or the time domain.

Parameter measurements can be customized to determine up to five quantities from the list in the table at the beginning of this chapter on different signals. These customized parameter measurements can also be used for pass/fail testing against chosen limits.

For all of these modes, statistics on the parameter values are accumulated and can be displayed. In addition to the overall number of sweeps used, each parameter has its average, lowest and highest value. The standard deviation of the parameter is also calculated.

STANDARD VOLTAGE PARAMETERS

This class of parameters measures for one trace:

- Peak-to-Peak (amplitude between maximum and minimum sample values)
- Mean of all sample values (corrected for periodic signals)
- Standard Deviation (equivalent to RMS- DC component)
- RMS of all sample values (corrected for periodic signals)
- Amplitude of the signal

MEASURE	
OFF Cursors Parameters	
mode	
Std Voltage Std Time Custom Pass Fail	
statistics OFF On	
on displayed (trace) <input type="checkbox"/>	
from 0.00 div Track OFF On	
to 10.00 div 1000 points	

Off/Cursors/Parameters

Select Parameters.

mode

Select Standard Voltage parameters.

statistics

This shows the average, the lowest, the highest, and the standard deviation of a parameter, as well as the number of sweeps included in the statistics. The number of sweeps is cleared each time the acquisition conditions change, or by pressing the CLEAR SWEEPS button.

The accumulation of statistics continues, even if the statistics are not shown, as long as Parameters are selected.

on displayed (trace)

Selects the trace for which the voltage parameters are measured.

from

Determines the starting point (in screen divisions) for parameter measurements.

to

Determines the end point (in screen divisions) for parameter measurements. It also indicates the total number of data points used for the measurements.

MENU CONTROLS

STANDARD TIME PARAMETERS

This class of parameters measures for one trace:

- Period
- Width (at 50% amplitude)
- Risetime (10-90% of amplitude)
- Falltime (90-10% of amplitude)
- Delay (from trigger to first 50% amplitude point)

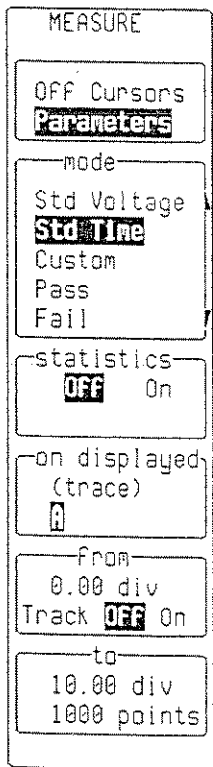

Off/Cursors/Parameters

Select Parameters.

mode

Select Standard Time parameters.

statistics

This shows the average, the lowest, the highest, and the standard deviation of a parameter, as well as the number of sweeps included in the statistics. The number of sweeps is cleared each time the acquisition conditions change, or by pressing the CLEAR SWEEPS button.

The accumulation of statistics continues, even if the statistics are not shown, as long as Parameters are selected.

on trace

Selects the trace for which the time parameters are measured.

from

Determines the starting point (in screen divisions) for parameter measurements.

to

Determines the end point (in screen divisions) for parameter measurements. It also indicates the total number of data points used for the measurements.

CUSTOM PARAMETERS

In this parameter measurement mode, up to five parameters selected from the list in the table at the beginning of this chapter can be displayed for different traces.

MEASURE
OFF Cursors Parameters
mode Std Voltage Std Time CUSTOM Pass Fail
statistics OFF On
CHANGE PARAMETERS
from 0.00 div Track OFF On
to 10.00 div

Off/Cursors/Parameters

Select Parameters.

mode

Select Custom parameters.

statistics

This shows the average, the lowest, the highest, and the standard deviation of a parameter, as well as the number of sweeps included in the statistics. The number of sweeps is cleared each time the acquisition conditions change, or by pressing the CLEAR SWEEPS button.

The accumulation of statistics continues, even if the statistics are not shown, as long as Parameters are selected.

CHANGE PARAMETERS

The Change Parameters menu is used to select the quantities and the traces for which these quantities are to be measured (see description given subsequently in this chapter).

from

Determines the starting point (in screen divisions) for parameter measurements.

to

Determines the end point (in screen divisions) for parameter measurements.

MENU CONTROLS

ADDING OR DELETING CUSTOM PARAMETERS

This menu is used to choose the custom parameters that need to be displayed.

CHANGE PARAM

On line
1 2 3 4 5

DELETE ALL PARAMETERS

measure
--
ampl
area
base
cycles

of
1 2 3 4
A B C D

on line

Up to five different parameters are displayed, each on a separate line. This button selects the line to be modified.

DELETE ALL PARAMETERS

Deletes all parameters previously selected.

measure

Selects the new parameter to be measured on this line.

of

Selects the trace on which the parameter will be measured.

PASS/FAIL TESTING

PASS/FAIL testing can be performed in two different ways:

1. PASS/FAIL tests on parameters

Up to five parameters can be tested simultaneously against limits.

2. PASS/FAIL tests on a tolerance mask

A trace is compared to a tolerance mask.

Whether the test PASSES or FAILS, any or all of the following actions can be provoked:

- Stop capturing further signals
- Dump the screen image to a hardcopy unit
- Store selected traces to internal memory, to a memory card (optional), or to a floppy disk (optional)
- Sound the buzzer
- Emit a pulse on the CAL BNC

The Pass/Fail display shows the results on the current waveforms, the number of events passing and the total number of sweeps treated, as well as the actions to be taken.

MENU CONTROLS

MEASURE

OFF Cursors
Parameters

mode
Std Voltage
Std Time
Custom
Pass
Fail

testing
OFF **On**

CHANGE TEST CONDITIONS

from
0.00 div
Track **OFF** On

to
10.00 div

Off/Cursors/Parameters

Select Parameters.

mode

Select Pass or Fail.

testing

Testing can be disabled in order to observe only the parameter variations.

CHANGE TEST CONDITIONS

The Change Test Conditions menu is used to choose the class of tests, the quantities and traces to be measured and their limits, or the tolerance mask, as well as the actions to be performed according to the result of the test (see description given subsequently in this chapter).

from

Determines the starting point (in screen divisions) for parameter measurements.

to

Determines the end point (in screen divisions) for parameter measurements.

CHANGE PASS/FAIL TEST
ON PARAMETERS

CHANGE TEST
On line 1 2 3 4 5 Action
Test on Param Mask ---(No Test)
choose Param Limit
DELETE ALL TESTS
measure -- ampl area base cycles
of 1 2 3 4 A B C D

on line

Up to five different parameters are displayed, each on a separate line. This menu button selects the line to be modified. To change Action see page 22-20.

test on

Set to test on Param (for tests on Masks see page 22-17). Set to ---(No Test) if no test is required on the selected line.

choose

Set to Param. To change Limit see page 22-16.

DELETE ALL TESTS

Deletes all tests previously selected.

measure

Selects the new parameter to be measured on this line.

of

Selects the trace on which the parameter will be measured.

MENU CONTROLS

CHANGE LIMITS FOR PASS/FAIL TESTS ON PARAMETERS

CHANGE TEST
On line 1 2 3 4 5 Action
Test on Param Mask ---(No Test)
choose Param Limit
DELETE ALL TESTS
True if < >
limit +0.14 E-01 3 digits
SET TO LATEST VALUE

On line

Up to five different tests are displayed, each on a separate line. This button selects the line of the test to be modified.

test on

Set to test on Param (for tests on Masks see page 22-17).

choose

Set to Limit (to change Param see page 22-15).

DELETE ALL TESTS

Deletes all tests previously selected.

True if

Selects the adequate relation – smaller than < , or greater than >.

limit

Three fields can be manipulated separately to modify a limit, its mantissa, its exponent, and the number of digits to represent the mantissa. The menu button is used to choose the field, and the menu knob is used to modify the number in that field.

SET TO LATEST VALUE

This menu button is used to set the limit to the latest measured value, to serve as a starting value for the final adjustment.

CHANGE PASS/FAIL TEST
ON A MASK

CHANGE TEST
On line 1 2 3 4 5 Action
Test on Param Mask ---(No Test)
MODIFY MASK
True if all points some points
of 1 2 3 4 A B C D
inside A B C D

on line

Up to five different parameters are displayed, each on a separate line. This menu button selects the line to be modified. To change Action see page 22-20.

test on

Set to **Mask** (for tests on Parameters see page 22-15). Set to **---**(No Test) if no test is required on the selected line.

MODIFY MASK

Use this menu button to modify the mask settings.

True if

Selects test condition on the mask.

of

Selects trace to be tested.

inside/outside

Selects mask trace.

Note: When performing pass/fail testing against a mask, please note that the test is affected by horizontal and vertical zooming of the mask trace. Also, the test will be made inside the area bordered by the parameter cursors.

MENU CONTROLS

GENERATING A MASK FROM A WAVEFORM

MODIFY MASK
From Card Disk W'form
into D=M4 M1 M2 M3 <input checked="" type="checkbox"/>
INVERT MASK M4
Use W'form <input checked="" type="checkbox"/> 2 3 4 A B C D M1 M2 M3 M4
MAKE MASK M4
delta V 0.50 div
delta T 0.20 div

from

Select W'form.

into

Select D=M4 if the mask has to be automatically displayed on the screen, otherwise select M1 to M4. Using the Waveform Recall menu, memories M1 to M4 can be recalled to traces A to D for display (see page 21-1).

INVERT MASK

Use this menu button to generate an inverted mask.

Use W'form

Select the waveform to be used as a reference. The mask will be generated around this waveform.

MAKE MASK

Use this menu button to generate the mask.

delta V

Select tolerance in amplitude, using the menu knob attributed to this field.

delta T

Select tolerance in time, using the menu knob attributed to this field.

RECALLING A MASK
FROM A CARD OR DISK

MODIFY MASK	
from	
Card	DISK
W'form	
into	
D=M4	
M1 M2 M3	M4
INVERT MASK	
M4	
DO RECALL	
SC1.000	
File	
SC1	000
SC2	001
SC2	002
SC3	003
SC4	004
27-NOV-92	
10:00:32	
Size 409	

from

Select Card or Disk.

into

Select D=M4 if the mask has to be automatically displayed on the screen, otherwise select M1 to M4.

INVERT MASK

Use this menu button to generate an inverted mask.

DO RECALL

Use this menu button to recall the mask.

File

Select the appropriate mask, using the menu knob attributed to this field.

MENU CONTROLS

SETTING PASS/FAIL ACTIONS

Depending on the result of the test – PASSEd or FAILed – certain actions can be taken, as described below.

CHANGE TEST

On line
1 2 3 4 5
Action

DELETE ALL ACTIONS

IF
Pass Fail

Then:

Stop	No
Stone	No
Dump	No
Beep	No
Pulse	No

Store
No Yes

on line

Select Action.

DELETE ALL ACTIONS

Deletes all previously selected actions.

if

The action can be taken if the test PASSEs or FAILs.

Then:

Selects the action to be taken.

The bottom field enables or disables the action to be taken.

The Panel Setups menu is used to:

- Save the instrument's configuration (Panel Setup) to a non-volatile memory, to the memory card, or to the floppy disk.
- Recall one of the Panel Setups from a non-volatile memory, from the memory card, or from the floppy disk.

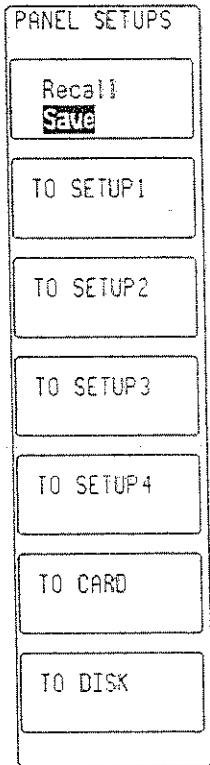

Save

Select **Save** in the top menu-field (to recall a setup see next menu).

TO SETUP

Use the appropriate button to select one of the four setups available.

TO CARD

Use this button to save a setup file to the memory card.

TO DISK

Use this button to save a setup file to the floppy disk.

MENU CONTROLS

PANEL SETUPS	
Recall	Save
FROM SETUP1	21-DEC-1992 16:56:44
FROM SETUP2	21-DEC-1992 16:56:51
FROM SETUP3	21-DEC-1992 16:56:55
FROM SETUP4	Empty
FROM DEFAULT SETUP	
From Card or Disk	

Recall

Select Recall in the top menu-field.

FROM SETUP..

Use the appropriate button to select one of the four setups available.

FROM DEFAULT SETUP

Use this button to select a factory-defined default setup.

from Card or Disk

Use this command to go to the Recall Setups menu to recall a setup file on the card or on the disk (see next menu).

RECALLING A SETUP FROM
A CARD OR DISK (OPTIONAL)

RECALL SETUPS	
From	
Card	DISK
27-NOV-92	
10:01:22	
Size 3083	
DO RECALL	
P001.PNL	
File	
P000	PNL
P001	PNL
P002	PNL
P003	PNL
P004	PNL

from
Select Card or Disk.

DO RECALL
Performs the recall from the selected filename.

File
Selects the setup file, using the attributed menu knob.



The Show Status menu shows the following summaries of the instrument's status:

- Acquisition
- System
- Waveform text and trigger times
- Waveform

25-Feb-92
18:24:34
STATUS

ACQUISITION STATUS

	1	2
Vertical:		
V/div	.2 V	10 mV
Probe	x1	x100
Offset	140 mV	0.16 V
Coupling	DC50Ω	AC1MΩ

Bandwidth Limit OFF

Time base

Time/div	50. μs	Time/pnt	10 ns (-100 Ms/s)
RIS	OFF		
Sequence	OFF	Pts/div	5000

Trigger Edge Mode STOPPED

1 DC -0.032 V

Pre-trigger Delay 17% (85 μs)

The currently preselected Smart Trigger type is
Dropout

Acquisition
System
Text & Times
WaveForm

ACQUISITION SUMMARY

Shows for each channel the vertical sensitivity, probe attenuation, offset and coupling, followed by the timebase, trigger and delay status summaries.

MENU CONTROLS

25-Feb-92
18:32:48

Serial Number 931001126

Scft Version 9310M 01.5

Scft Options
WP01 WP02
M001

Hard Options

STATUS

Acquisition
System
Text & Times
WaveForm

SYSTEM SUMMARY

Shows the instrument's serial number, the firmware version, and the software or hardware options installed.

Show Status

25-Feb-92
18:22:84

For
waveForm
1

Segment	Time	Time since Segment 1
1)	25-Feb-1992 18:21:33	153.969 μ s
2)	25-Feb-1992 18:21:33	308.485 μ s
3)	25-Feb-1992 18:21:33	462.543 μ s
4)	25-Feb-1992 18:21:33	616.664 μ s
5)	25-Feb-1992 18:21:33	770.864 μ s
6)	25-Feb-1992 18:21:33	924.669 μ s
7)	25-Feb-1992 18:21:33	1.078675 ms
8)	25-Feb-1992 18:21:33	1.233049 ms
9)	25-Feb-1992 18:21:33	1.387096 ms
10)	25-Feb-1992 18:21:33	1.540943 ms
11)	25-Feb-1992 18:21:33	1.695185 ms
12)	25-Feb-1992 18:21:33	
13)	Not acquired	
14)	Not acquired	
15)	Not acquired	
16)	Not acquired	
17)	Not acquired	
18)	Not acquired	
19)	Not acquired	
20)	Not acquired	

STATUS

Acquisition System
Text & Times
WaveForm

For
1 2
A B C D
M1 M2 M3 M4

TEXT & TIMES SUMMARY

Shows the user text in the waveform descriptor (see Remote Control Manual), together with the trigger timing information.

MENU CONTROLS

25-Feb-92 18:19:44					STATUS
WAVEFORM	1	2	A	B	
Trigger date	25-Feb-1992	25-Feb-1992	25-Feb-1992	25-Feb-1992	Acquisition System Text & Times WaveForms
time	12:12:19	12:12:19	12:12:19	12:12:19	
For					
Vertical					
Scale/div	2.00 V	1.00 V	0.76 V	20.0 μ V	Channels Zoom+Math Memories Displayed
Offset	-0.08 V	0.51 V	0.40 V	-5.2 μ V	
Coupling	DC50 Ω	AC1M Ω	DC50 Ω	DC50 Ω	
BW-Limit	OFF	OFF	OFF	OFF	
Horizontal					
Scale/div	10 μ s	10 μ s	1.0 μ s	5.0 MHz	Channels Zoom+Math Memories Displayed
Offset	17 % Pre	17 % Pre	38.60 μ s	0.0 MHz	
Scale/pnt	10 ns	10 ns	10 ns	10 kHz	
Pnts/div	1000	1000	100	500	
Record Type	SINGLE	SINGLE	SINGLE	SINGLE	
Segments	NONE	NONE	NONE	NONE	
Sweeps					

WAVEFORM SUMMARY

Shows detailed status information on channels, zoom + math traces, memories, or the displayed traces. Use the bottom menu box to select the desired summary.

Show Status

Vertical Analog Section

Bandwidth (-3 dB):
 (9310/14): 50 Ω DC coupling: 300 MHz
 @ 50 Ω: DC to 300 MHz. @ 2mV/div: DC to 270 MHz
 @ 1 MΩ DC: DC to 250 MHz typical at the probe tip
 (9304): DC to 175 MHz

Input impedance: 1 MΩ // 15 pF and 50 Ω ± 1%

Sensitivity range: 2 mV/div to 5 V/div, continuously variable. Fixed settings range from 2 mV/div to 5 V/div in a 1, 2, 5 sequence

Vertical expansion: up to 5 times (with averaging, up to 50 times or 40 μV/div sensitivity)

Scale factors: Probe attenuation factors of ×1, ×10, ×100, ×1000 or ×10000 may be selected.

Offset: 2 – 9.9 mV/div ± 120 mV
 10 – 199 mV/div ± 1.2 V
 0.2 V – 5 V/div ± 24 V

DC accuracy: ≤ ±2%.

Bandwidth limiter: 30 MHz (-3 dB) typical.

Max input voltage: 250 V (DC + peak AC ≤10 kHz) at 1 MΩ, ± 5 V DC (500 mW) or 5 V RMS at 50 Ω.

Vertical Digital Section

ADCs: One per channel, 8-bit flash.

Sampling rate: Up to 100 megasamples/sec for transients, up to 10 gigasamples/sec for repetitive signals, simultaneously on all channels.

Aperture uncertainty: ±10 psec.

Acquisition memories: (8-bit)

size/channel		
9310/14L	9310/14M	9304/10/14
1M	50K	10K

Acquisition memory segmentation:

number of segments		
9310/14L	9310/14M	9304/10/14
2 – 2000	2 – 200	2 – 50

APPENDIX A

Reference memories (16-bit): Four reference memories (M1, M2, M3, M4).

Waveform processing memories (16-bit): Four waveform processing traces (A, B, C, D)

size of each reference or waveform processing memory		
9310/14L	9310/14M	9304/10/14
50K	50K	10K

Horizontal Section

Time Base

Range: 1 nsec/div to 1000 sec/div.

Clock accuracy: $\leq \pm 0.002\%$

Interpolator resolution: 10 psec.

Interpolator accuracy: 15 ps RMS

Acquisition Modes

Random Interleaved Sampling (RIS) for repetitive signals from 1 nsec/div to 5 μ sec/div.

Single shot for transient signals and repetitive signals from 50 nsec/div to 200 msec/div.

Roll mode timebase range: 500 ms – 1000 s/div (9310/14L with 1 M waveform: 10 s – 1000 s/div)

Sequence: Stores multiple events in segmented acquisition memories (see acquisition memory segmentation above).

Trigger

Pre-trigger recording: Adjustable in 1% increments to 100% of full scale (grid width).

Post-trigger delay: Adjustable in 0.1 division increments up to 10,000 divisions.

External trigger input: 1 M Ω , < 15pF, 250 V max. (DC + peak AC \leq 10 kHz).

External trigger range: ± 2 V in Ext, ± 20 V in Ext/10.

Rate: Up to 500 MHz using HF trigger coupling (up to 300 MHz for the 9304).

Timing: Trigger timing (date and time) is listed in the memory status menu. The timing of subsequent triggers in sequence mode is measured with 1 sec absolute resolution, or nanosecond resolution relative to the time of the first trigger.

Standard Trigger

Sources: Chan1, Chan2, (Chan3 and Chan4 for 4-channel models), Line, Ext, Ext/10. Slope, coupling and level can be set individually for each source.

Slope: Positive, negative, window.

Coupling: HF, AC, LF REJ, HF REJ, DC.

Hold-off by time: 25 nsec to 20 sec.

Hold-off by events: 0 to 1,000,000,000 events.

SMART Trigger

Pulse Width: Trigger on pulse widths within or outside of time limits selectable between 2.5 ns and 20 s.

Interval Width: Trigger on pulse distances within or outside of two time limits selectable between 2.5 ns and 20 s.

Dropout: Trigger whenever the input signal drops out for longer than a selectable timeout.

State/Edge qualified: Trigger on any source only if a given state (or transition) has occurred on one of the other possible sources. From the time of occurrence of the latter, a delay can be defined in terms of time or number of events on the trigger channel. Alternatively, a trigger is accepted within a time window which starts at the transition of one of the other trigger sources.

TV: Allows stable triggering on TV signals that comply with PAL, SECAM or NTSC standards. Selection on both line (up to 1500) and field number (up to 8) is possible.

Display

CRT: 12.5×17.5 cm (5 × 7 inches); magnetic deflection; raster type.

Resolution: 810 × 696 points.

Real-time clock: Date, hours, minutes, seconds.

Grid: Internally generated; separate intensity control for grid and waveforms. Single, dual and quad grid modes.

Hard copy: HP QuietJet, ThinkJet, LaserJet, PaintJet, DeskJet and EPSON printers, as well as HP7470 and HP7550 plotters or compatible instruments, can be used to make hard copies of the display. The TIFF graphics format is also supported in order to incorporate the oscilloscope screens in word processing or desktop publishing software packages. Screen dumps are activated by a front-panel button or via remote control.

APPENDIX A

XY mode: Displays pairs of data points of any two sources (Channels or Traces A, B, C, D). Can be combined with persistence.

Grids can be chosen for XY only or XY plus normal waveform display of sources in a common grid or separately.

Time and XY voltage cursors are available.

Persistence mode: Displays consecutively acquired traces on top of each other, allowing waveform trends to be examined. Simultaneous display of normal trace is superimposed.

Time and XY voltage cursors are available.

Cursors

Relative time: Two cursors provide time measurements with a resolution of $\pm 0.05\%$ of full scale for unexpanded traces; up to $\pm 10\%$ of the data point sampling interval for expanded traces. The corresponding frequency information is also provided.

Relative voltage: Two horizontal bars measure voltage differences up to $\pm 0.2\%$ of full scale for each trace in single grid mode.

Absolute time: A cross-hair marker measures time relative to the trigger as well as absolute voltage versus signal ground.

Absolute voltage: A reference bar measures absolute voltage with respect to ground.

Pulse parameters: Two cross-hair cursors are used to define a region of interest for which pulse parameters will be calculated automatically.

Auto-setup

Pressing the auto-setup button automatically scales the time-base, trigger and sensitivity settings to display a wide range of repetitive input signals.

Type of signals detected: Repetitive signals with amplitudes between 2 mV and 40 V, frequency above 50 Hz and a duty cycle greater than 0.1%.

Auto-setup time: Approximately 2 sec.

Vertical find

Automatically scales sensitivity and offset.

Waveform Processing

Waveform processing routines are called and set up via menus. These include arithmetic functions (add, subtract, multiply, divide, negate, identity), and summation averaging (up to 1000 signals).

Specifications

Pulse parameters: Based on ANSI/IEEE Std 181-1977 "Standard on Pulse Measurement and Analysis by Objective Techniques". The terminology is derived from IEEE Std 194-1977 "Standard Pulse Terms and Definitions".

Automatic measurements determine:

Amplitude	Frequency	Period
Area	Maximum	Pulse width
Base	Mean	Risetime
Cycles	Minimum	RMS
Delay	Overshoot Negative	Standard deviation
Duty Cycle	Overshoot Positive	Top
Falltime	Peak-Peak	

Statistics can be performed on each of the automatic measurements, showing the following statistical information:

- Average
- High
- Low
- Standard Deviation

Automatic PASS/FAIL allows up to five waveform parameters to be tested against selectable thresholds. A waveform may also be tested against a tolerance template which can be generated inside the instrument.

Optional Processing

Extra processing power can be added by installing LeCroy's waveform processing options. Option WP01 provides waveform characterization in high resolution mode up to 11 bits, and extended mathematical analysis (integration, differentiation, etc.), as well as averaging and extrema mode for the accumulation of maximum and minimum values. Option WP02 performs spectral analysis (FFT processing).

Hardware Options

GP01: Internal printer + Centronics interface. Roster printer, thermal, resolution 190 DP1. Printout size: 126 x 90 mm.

FD01: 3.5" floppy drive + Centronics interface. DOS format, supports 1.44 Mb and 720 Kb densities.

MC01/04: PCMIA 1.0 memory card reader + 512k memory card.

APPENDIX A

Remote Control

Front-panel controls, including variable gain, offset, position controls and cursors, as well as all internal functions, are programmable.

RS-232-C port: For computer/terminal control or plotter connection. Asynchronous up to 19200 baud.

GPIB port: (IEEE-488). Configured as talker/listener for computer control and fast data transfer.

Local/remote: Remote control can be interrupted for local (manual) control at any time (except when in remote control with the lock-out state selected) by pushing a button on the front panel.

Probes

One P9020 ($\times 10$, 10 M Ω // 15 pF) probe supplied per channel.

Probe calibration: 1 kHz square wave, 1 V p-p.

General

Temperature: 5 to 40° C (41 to 104° F) rated; 0 to 50° C (32 to 122° F) operating.

Humidity: < 80%.

Power required: 90 – 250 V AC, 45 to 66 Hz, 150 W.

Shock and vibration: Meets requirements of MIL-STD-810C modified to LeCroy design specifications, and MIL-T-28800C.

Battery backup: Accumulators maintain front-panel settings for two years.

Dimensions: (HWD) 21 x 37 x 41 cm (8 1/2 x 14 1/2 x 16 1/4 inches).

Weight: 10kg (22lbs) net, 15.5kg (34lbs) shipping.

Warranty: two years.

ENHANCED RESOLUTION

Quite often the high sampling rate available in LeCroy oscilloscopes is higher than is actually required for the bandwidth of the signal being analyzed. This oversampling, facilitated by the oscilloscope's long memories, can be used to advantage by filtering the digitized signal in order to increase the effective resolution of the displayed trace. This is similar to smoothing the signal with a simple moving average filter, except that it is more efficient in terms of bandwidth, and has better passband characteristics. It can be used instead of averaging successive traces for waveforms with single-shot characteristics.

Advantages of Enhanced Resolution

Two subtly different characteristics of the instrument are improved by the enhanced resolution filtering:

1. In all cases the resolution (i.e. the ability to distinguish closely-spaced voltage levels) is improved by a fixed amount for each filter. This is a true increase in resolution which occurs whether or not the signal is noisy, and whether or not it is a single-shot or a repetitive signal.
2. The signal-to-noise ratio (SNR) is improved in a manner which depends on the form of the noise in the original signal. This occurs because the enhanced resolution filtering decreases the bandwidth of the signal, and will therefore filter out some of the noise.

Implementation

The oscilloscope implements a set of linear phase finite impulse response (FIR) filters, optimised to provide fast computation, excellent step response and minimum bandwidth reduction for resolution improvements of between 0.5 and 3 bits in 0.5 bit steps. Each 0.5 bit step corresponds to a bandwidth reduction by a factor of two, allowing easy control of the bandwidth/resolution trade-off. The parameters of the six filters are given in the following table:

Resolution Increase (Enhancement)	-3 dB Bandwidth (x Nyquist)	Filter Length (samples)
0.5	0.5	2
1	0.241	5
1.5	0.121	10
2	0.058	24
2.5	0.029	51
3	0.016	117

Parameters of the FIR
Enhanced Resolution Filters

The filters used are low-pass filters, so the actual increase in SNR obtained in any particular situation will depend on the power spectral density of the noise present on the signal. The improvement in SNR corresponds to the improvement in resolution if the noise in the signal is white, i.e. evenly distributed across the frequency spectrum. If the noise power is biased towards high frequencies then the SNR improvement will be better than the resolution improvement. Whereas if the noise is mostly at lower frequencies, the improvement may not be as good as the resolution improvement. The improvement in the SNR due to the removal of coherent noise signals (for example, feed-through of clock signals) depends on whether the dominant frequency components of the signal fall in the passband of the filter or not. This can easily be deduced by using the spectrum analysis option (WP02) of the oscilloscope.

The filters used for the enhanced resolution function have an exactly linear phase response. This has two desirable properties. Firstly, the filters do not distort the relative position of different events in the waveform even if the frequency content of the events is different. Secondly, by also using the fact that the waveforms are stored, the delay normally associated with filtering (between the input and output waveforms) can be exactly compensated for during the computation of the filtered waveform.

All filters have been implemented to have exactly unity gain (at low frequency). Therefore, enhanced resolution should not cause overflow if the source data were not overflowed. If part of the source trace had overflowed, filtering will be allowed, but it must be remembered that the results in the vicinity (within the length of the filter impulse response) of the overflowed data will be incorrect. This is permitted because in some circumstances an overflow may be a spike of only one or two samples. The energy in this spike might not be sufficient to significantly affect the results, so it would be undesirable to disallow the whole trace in this case.

When should Enhanced Resolution be used?

There are two main situations for which enhanced resolution is especially useful. Firstly, if the signal is noticeably noisy (and measurements of the noise are not required), the signal can be "cleaned up" by using the enhanced resolution function. Secondly, even if the signal is not particularly noisy, but high precision measurements of the waveform are required (perhaps when using Expand with high vertical gain) then enhanced resolution will increase the resolution of the measurements.

In general, enhanced resolution replaces the averaging function in situations where the data record has a single-shot or slowly repetitive nature and averaging cannot be used.

The following examples illustrate uses of the enhanced resolution function in these situations.

APPENDIX B

Low-pass filtering

The figure below shows the spectrum of a square signal before (top grid) and after (bottom grid) enhanced resolution processing. The result clearly shows how the filter rejects high-frequency components from the signal. The higher the bit enhancement, the lower the resulting bandwidth.

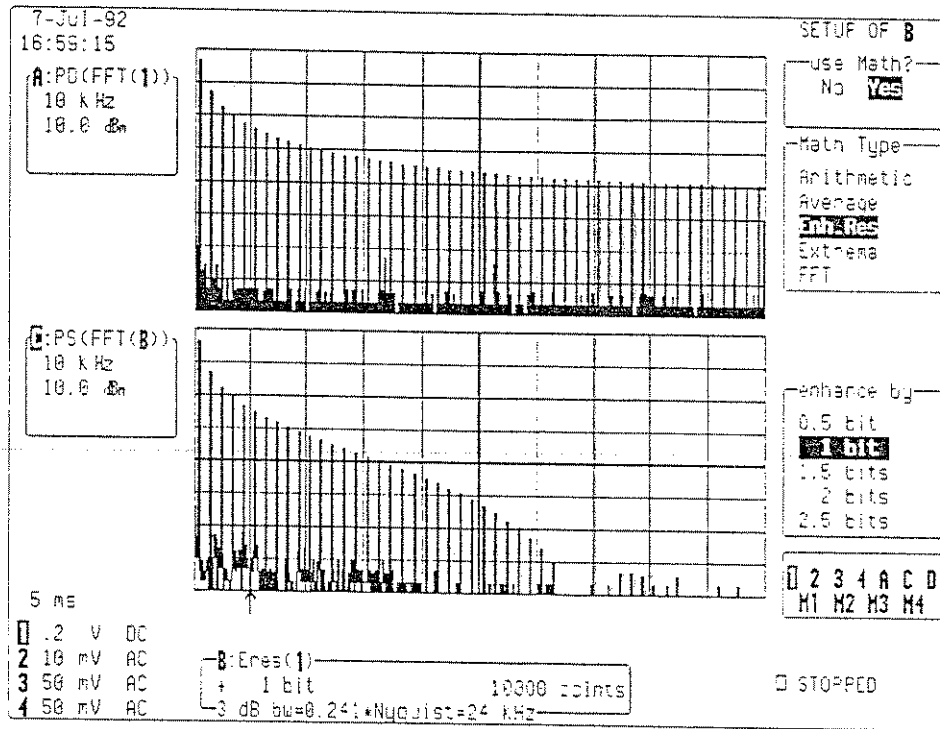

Increasing Vertical Resolution

In the following example the bottom trace has been significantly enhanced by a 3-bit enhanced resolution function.

Note: The original signal being highly over-sampled, the resulting bandwidth is still high enough for the signal not to be distorted.

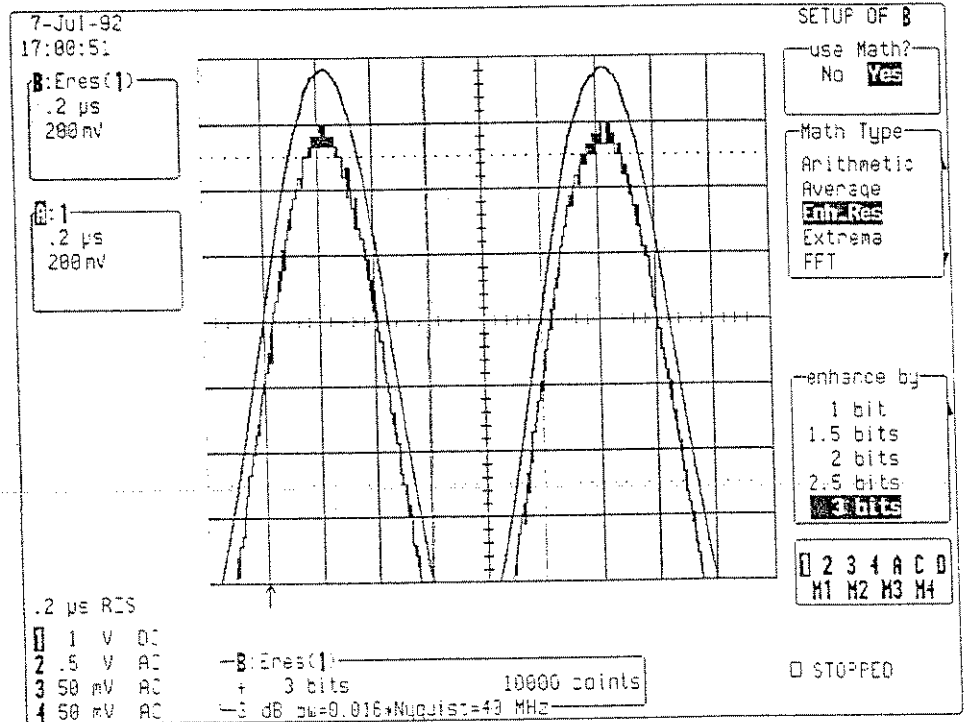

APPENDIX B

Reducing Noise

The following figure shows the effect of enhanced resolution on a noisy signal.

The original trace (top grid) has been processed by a 2-bit enhanced resolution filter.

The result (bottom grid) shows a "smooth" trace where most of the noise has been eliminated.

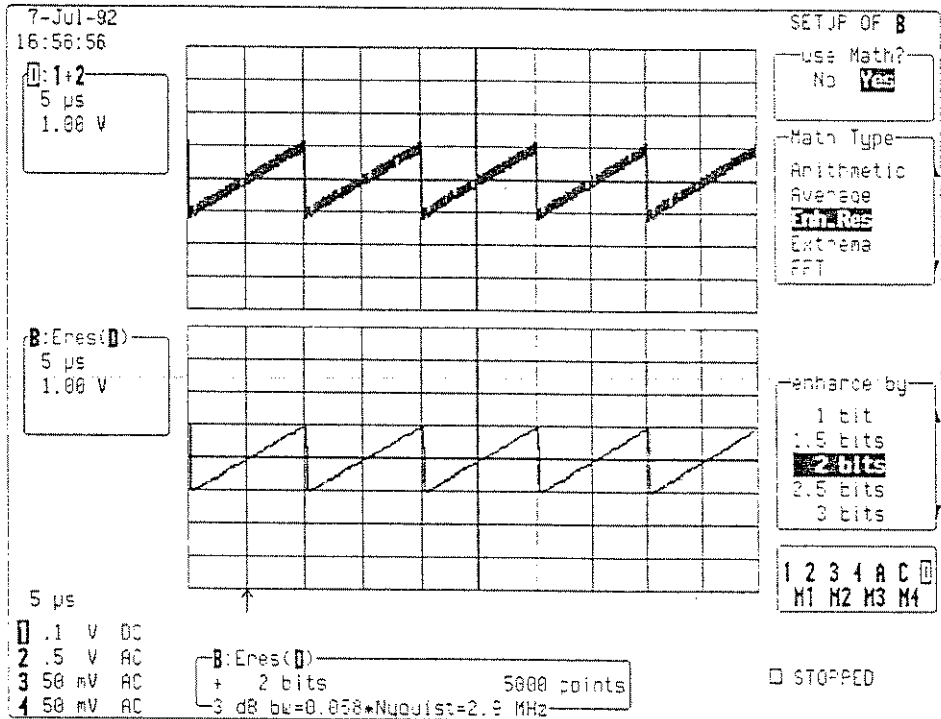

Cautionary notes

The enhanced resolution function only improves the resolution of a trace, it cannot improve the accuracy or linearity of the original quantization by the 8-bit ADC.

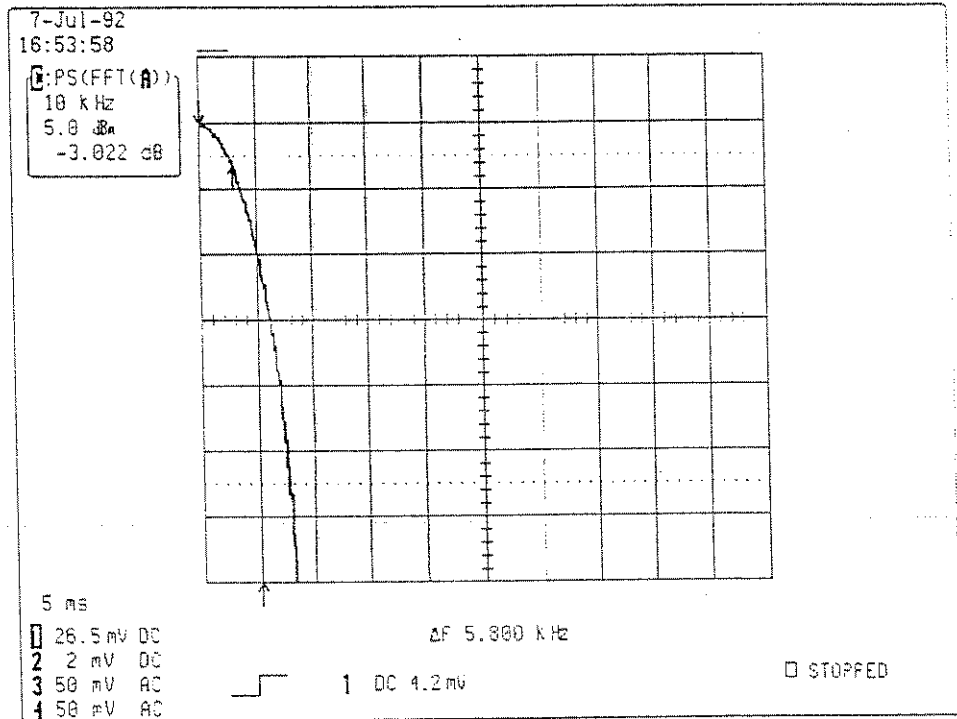

The constraint of good temporal response for the enhanced resolution filters excludes the use of maximally-flat filters. Therefore, the passband will cause slight signal attenuation for signals near the cut-off frequency. One must be aware when using these filters that the highest frequencies passed may be slightly attenuated. The frequency response of a typical enhanced resolution filter (the 2-bit enhancement filter) is shown in the above figure. The -3 dB cut-off frequency at 5.8% of the Nyquist frequency is marked.

The filtering must be performed on finite record lengths, therefore the discontinuities at the ends of the record cause data to be corrupted at these points. These data points are not displayed by the oscilloscope and so the trace becomes slightly shorter after filtering.

APPENDIX B

The number of samples lost is exactly equal to the length of the impulse response of the filter used, and thus varies between 2 and 117 samples. Because the oscilloscope has very long waveform memories this loss is not normally noticed (it is only 0.2% of a 50,000 point trace). However, it is possible to ask for filtering on a record so short that there would be no data output. The oscilloscope will not allow filtering in this case.

The FFT option (WP02) adds the spectrum analysis capability to the oscilloscope. This appendix gives additional information on its use.

Spectra of single time-domain waveforms can be computed and displayed and Power Averages can be obtained over as many as 50000 spectra.

Spectra are displayed with a linear frequency axis running from zero to the Nyquist frequency. The frequency scale factors (Hz/div) are in a 1-2-5 sequence. The Nyquist frequency is at the right-hand edge of the trace.

The processing equation is displayed at the bottom of the Fourier Transform menu, together with three key parameters which characterize an FFT spectrum:

- 1) Transform Size N (number of input points)
- 2) Nyquist frequency
- 3) Δf (the frequency increment) between two successive points of the spectrum. These parameters are related as follows:

$$\text{Nyquist frequency} = \Delta f \cdot N/2$$

Also note that $\Delta f = 1/T$, where T is the duration of the input waveform record ($10 \cdot \text{time/div}$).

The number of output points is equal to $N/2$.

The menu allows the user to set the following parameters:

Type

Power Spectrum (dBm) is the signal power (or magnitude) represented on a logarithmic vertical scale. 0 dBm corresponds to the voltage (0.316 V peak) which is equivalent to 1 mW into 50 Ω . The power spectrum is suitable for characterizing spectra which contain isolated peaks.

Power Density (dBm) is the signal power normalized to the bandwidth of the equivalent filter associated with the FFT calculation. The power density is suitable for characterizing broad-band noise.

Magnitude (same units as the input signal) is the peak signal amplitude represented on a linear scale.

Phase (degrees) is measured with respect to a cosine whose maximum occurs at the left-hand edge of the screen, at which point it has 0°; similarly, a positive-going sine starting at the left-hand edge of the screen has -90° phase.

Real, Imaginary and Real + Imaginary (same units as the input signal) represent the complex result of the FFT processing.

Maximum Number of Points FFT spectra are computed over all of the source time-domain waveform. This parameter limits the number of points used for FFT processing. If the input waveform contains more points than the selected maximum, these are decimated prior to FFT processing. If the input waveform has fewer points, all points are used.

Window Type The window type defines the bandwidth and shape of the equivalent filter associated with the FFT processing.

The **Rectangular window** is normally used when:

- a) the signal is a transient which is completely contained in the time-domain window.
- b) the signal is known to have a fundamental frequency component which is an integer multiple of the fundamental frequency of the window.

Signals not in this class show varying amounts of spectral leakage and scallop loss, which can be corrected by using one of the other windows.

The popular **Von Hann (Hanning)** and **Hamming** windows reduce leakage and improve amplitude accuracy. However, the frequency resolution is also reduced.

The **Flat Top** window provides excellent amplitude accuracy, with moderate reduction of leakage, at the cost of frequency resolution.

The **Blackman-Harris** window reduces the leakage to a minimum, with a trade-off in frequency resolution.

The table in the FFT glossary in this section shows the parameters of equivalent filters.

FFT POWER AVERAGE A function can be defined as the **Power Average** of FFT spectra computed by another function.

PROCESSING FACILITIES Other waveform processing functions such as **Averaging** and **Arithmetic** can be applied to waveforms before the FFT processing. Time-domain averaging prior to FFT can be used if a stable trigger is available. It will reduce the random noise in the signal.

The FFT frequency range (i.e. Nyquist frequency) and the frequency resolution can be controlled as follows:

- To increase the frequency resolution, increase the length of the time-domain waveform record (i.e. use a slower time base).
- To increase the frequency range, increase the effective sampling frequency (i.e. increase the maximum number of points or use a faster time base).

The **Memory Status** menu displays parameters of the waveform descriptor (number of points, horizontal and vertical scale factors and units, etc.).

CURSORS

To read the amplitude and frequency of a data point, the **Absolute Time Cursor** can be moved over into the frequency domain by going beyond the right-hand edge of a time-domain waveform.

The **Relative Time Cursors** can be moved over into the frequency domain to simultaneously indicate the frequency difference and the amplitude difference between two points on each frequency-domain trace.

The **Absolute Voltage Cursor** reads the absolute value of a point in a spectrum in the appropriate units, and the **Relative Voltage Cursors** indicate the difference between two levels on each trace.

FFT ALGORITHMS

A summary of algorithms used in the oscilloscope's FFT computation is given for reference.

- 1) If the maximum number of points is smaller than the source number of points, the source waveform data are decimated prior to the FFT. The decimated data cover the full length of the source waveform.

The resulting sampling interval and the actual transform size selected provide the frequency scale factor in a 1-2-5 sequence.

- 2) The data are multiplied by the selected window function.
- 3) FFT is computed, using a fast implementation of the DFT (Discrete Fourier Transform):

$$X_n = \frac{1}{N} \sum_{k=0}^{N-1} x_k \times W^{n \times k}$$

where x_k is a complex array whose real part is the modified source time-domain waveform, and whose imaginary part is 0

X_n is the resulting complex frequency-domain waveform

$$W = e^{(-j \times 2 \times \pi / N)}$$

N is the number of points in x_k and X_n

The generalized FFT algorithm, as implemented here, works on N which need not be a power of 2.

- 4) The resulting complex vector X_n is divided by the coherent gain of the window function, to compensate for the loss of the signal energy due to windowing. This compensation provides accurate amplitude values for isolated spectrum peaks.
- 5) The real part of X_n is symmetric around the Nyquist frequency, that is:

$$R_n = R_{N-n}$$

while the imaginary part is asymmetric, that is:

$$I_n = -I_{N-n}$$

The energy of the signal at a frequency n is distributed equally between the first and the second halves of the spectrum; the energy at frequency 0 is completely contained in the 0 term.

The first half of the spectrum (Re, Im), from 0 to the Nyquist frequency is kept for further processing and doubled in amplitude:

$$R'_n = 2 \times R_n \quad 0 \leq n < N/2$$

$$I'_n = 2 \times I_n \quad 0 \leq n < N/2$$

- 6) The resultant waveform is computed for the spectrum type selected.

If Real, Imaginary or both are selected, no further computation is needed. The appropriate part of the complex result is given as the result (R'_n or I'_n or $R'_n + jI'_n$, as defined above).

If Magnitude is selected, the magnitude of the complex vector is computed as:

$$M_n = \sqrt{R_n'^2 + I_n'^2}$$

Steps (1) to (6) above lead to the following result:

An AC sine wave of amplitude 1.0 V with an integral number of periods N_p in the time window, transformed with the rectangular window, results in a fundamental peak of 1.0 V magnitude in the spectrum at frequency $N_p \times \Delta f$.

However, a DC component of 1.0 V, transformed with the rectangular window, results in a peak of 2.0 V magnitude at 0 Hz.

The waveforms for the other available spectrum types are computed as follows:

$$\begin{aligned} \text{Phase: angle} &= \arctan(I_n/R_n) & M_n > M_{min} \\ \text{angle} &= 0 & M_n \leq M_{min} \end{aligned}$$

where M_{min} is the minimum magnitude, fixed at about 0.001 of the full scale at any gain setting, below which the angle is not well defined.

dBm Power Spectrum:

$$dBm \text{ PS} = 10 \times \log_{10} \left(\frac{M_n^2}{M_{ref}^2} \right) = 20 \times \log_{10} \left(\frac{M_n}{M_{ref}} \right)$$

where $M_{ref} = 0.316$ V (that is, 0 dBm is defined as a sine wave of 0.316 V peak or 0.224 V RMS, giving 1.0 mW into 50 Ω).

The "dBm Power Spectrum" is the same as "dBm Magnitude", as suggested by the above formula.

dBm Power Density:

$$dBm \text{ PD} = dBm \text{ PS} - 10 \times \log_{10} (\text{ENBW} \times \Delta f)$$

where ENBW is the equivalent noise bandwidth of the filter corresponding to the selected window

Δf is the current frequency resolution (bin width)

- 9) The FFT Power Average takes the complex frequency-domain data R'_n and I'_n for each spectrum generated in step (5) above, and computes the square of the magnitude

$$M_n^2 = R_n'^2 + I_n'^2,$$

sums M_n^2 and counts the accumulated spectra. The total is normalized by the number of spectra and converted to the selected result type using the same formulae as are used for the Fourier Transform.

EXAMPLES OF FFT PROCESSING

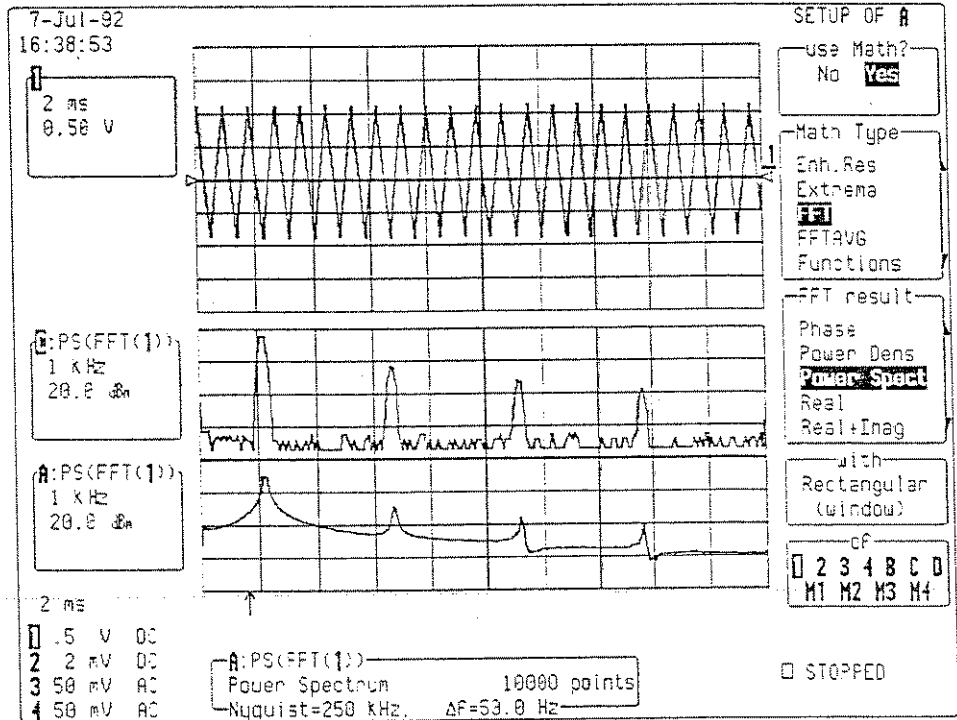

The Effect of Windowing

The figure above illustrates an example with spectral leakage and the use of an appropriate window to reduce the leakage.

Channel 1 (top trace) shows a triangular wave, approximately 1 kHz frequency.

The bottom trace is an expansion of an FFT with a **Rectangular** window. Each peak, and especially the fundamental component at 1 kHz, influences the spectrum over a wide range of frequencies due to the leakage of the signal power through the side lobes of the equivalent filter.

The middle trace is an expansion of another FFT of the same Channel 1 waveform, defined with the **Blackman-Harris** window. The leakage is clearly reduced, but the peaks around the harmonics are

APPENDIX C

wider. This reflects the increased bandwidth of the filter associated with the Blackman-Harris window.

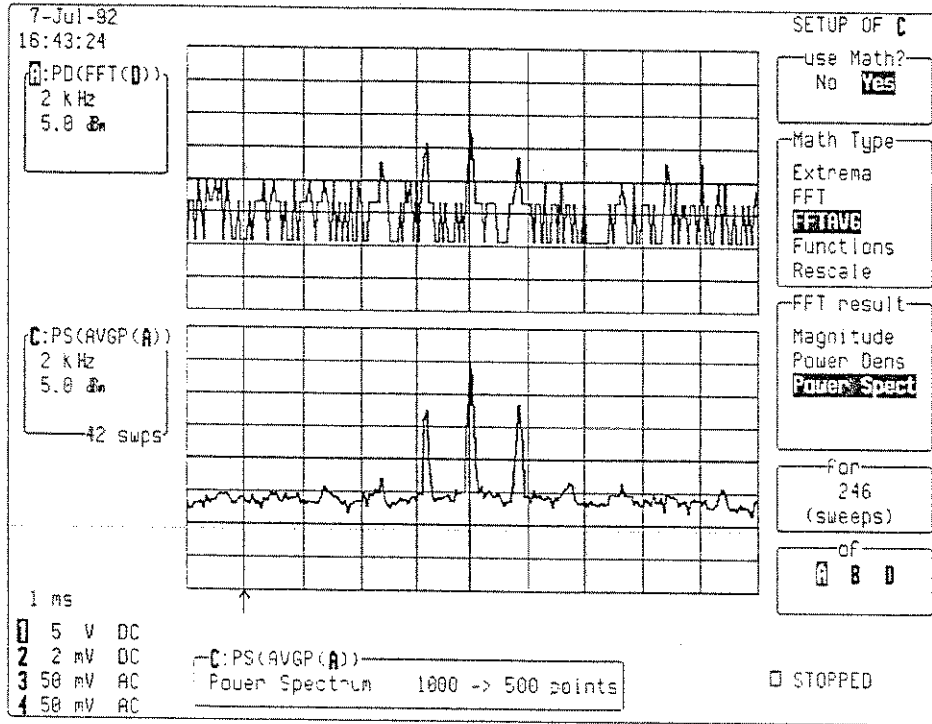

The Effect of FFT Averaging

The above figure shows an FFT of a noisy signal (top trace). By applying a power average to this FFT, all the incoherent noise is eliminated. The signal (Amplitude Modulation) is now clearly visible.

FFT GLOSSARY

This glossary defines terms frequently used in FFT spectrum analysis and relates them to the oscilloscope.

Aliasing

If the input signal to a sampling acquisition system contains components whose frequency is greater than the Nyquist frequency (half the sampling frequency), there will be less than two samples per signal period. The result is that the contribution of these components to the sampled waveform will be indistinguishable from that of components below the Nyquist frequency. This is called aliasing.

The user should select the time base and transform size resulting in a Nyquist frequency higher than the highest significant component in the time-domain record.

Coherent Gain

The normalized coherent gain of a filter corresponding to each window function is 1.0 (0 dB) for a rectangular window and less than 1.0 for other windows. It defines the loss of signal energy due to the multiplication by the window function. In the oscilloscope this loss is compensated. The table below lists the values for the windows implemented.

ENBW (Equivalent Noise Bandwidth)

For a filter associated with each frequency bin, ENBW is the bandwidth of an equivalent rectangular filter (having the same gain at the center frequency) which would collect the same power from a white noise signal. In the table below, ENBW is listed for each window function implemented and is given in bins.

Window type	Highest side lobe (dB)	Scallop loss (dB)	ENBW (bins)	Coherent gain (dB)
Rectangular	-13	3.92	1.0	0.0
von Hann	-32	1.42	1.5	-6.02
Hamming	-43	1.78	1.37	-5.35
Flat-Top	-44	0.01	2.96	-11.05
Blackman-Harris	-67	1.13	1.71	-7.53

WINDOW FREQUENCY-DOMAIN PARAMETERS

Filters

Computing an N-point FFT is equivalent to passing the time-domain input signal through N/2 filters and plotting their outputs against the frequency. The spacing of filters is $\Delta f = 1/T$ while the bandwidth depends on the window function used (see Frequency bins).

Frequency bins

The FFT algorithm takes a discrete source waveform, defined over N points, and computes N complex Fourier coefficients, which are interpreted as harmonic components of the input signal.

For a real source waveform (imaginary part equals 0), there are only N/2 independent harmonic components.

An FFT corresponds to analyzing the input signal with a bank of N/2 filters, all having the same shape and width, and centered at N/2 discrete frequencies. Each filter collects the signal energy that falls into the immediate neighborhood of its center frequency, and thus it can be said that there are N/2 "frequency bins".

The distance, in Hz, between the center frequencies of two neighboring bins is always:

$$\Delta f = 1/T$$

where T is the duration of the time-domain record in seconds.

The width of the main lobe of the filter centered at each bin depends on the window function used. The rectangular window has a nominal width at 1.0 bin. Other windows have wider main lobes (see table on page C-9).

Frequency Range

The range of frequencies computed and displayed is 0 Hz (displayed at the left-hand edge of the screen) to the Nyquist frequency (at the rightmost edge of the trace).

Frequency Resolution

In a simple sense, the frequency resolution is equal to the bin width, Δf . That is, if the input signal changes its frequency by Δf , the corresponding spectrum peak will be displaced by Δf . For smaller changes of frequency, only the shape of the peak will change.

However, the effective frequency resolution (i.e. the ability to resolve two signals whose frequencies are almost the same) is further limited by the use of window functions. The ENBW value of all windows other than the rectangular is greater than Δf , i.e. greater than the bin width. The table on page C-9 lists the ENBW value for the windows implemented.

Leakage

Observe the power spectrum of a sine wave having an integral number of periods in the time window (i.e. the source frequency equals one of the bin frequencies) using a rectangular window. The spectrum contains a sharp component whose value reflects accurately the source waveform's amplitude. For intermediate input frequencies this spectral component has a lower and broader peak.

The broadening of the base of the peak, stretching out into many neighboring bins is termed the leakage. It is due to the relatively high side lobes of the filter associated with each frequency bin.

The filter side lobes and the resulting leakage are reduced when one of the available window functions is applied. The best reduction is provided by the **Blackman-Harris** and the **Flat Top** windows. However, this reduction is offset by a broadening of the main lobe of the filter.

Numbers of Points

FFT is computed over the number of points (Transform Size) whose upper bounds are the source number of points and the maximum number of points selected in the menu.

FFT generates spectra having $N/2$ output points.

Nyquist Frequency

The Nyquist frequency is equal to one half of the effective sampling frequency (after the decimation), i.e. $\Delta f \times N/2$.

Picket Fence Effect

If a sine wave has a whole number of periods in the time domain record, the power spectrum obtained with a rectangular window will have a sharp peak, corresponding exactly to the frequency and amplitude of the sine wave. On the other hand, if a sine wave does not have a whole number of periods in the record, the spectrum peak obtained with a rectangular window will be lower and broader.

The highest point in the power spectrum can be 3.92 dB lower (1.57 times) when the source frequency is halfway between two discrete bin frequencies. This variation of the spectrum magnitude is called the picket fence effect (the loss is called the scallop loss).

All window functions compensate this loss to some extent, but the best compensation is obtained with the Flat Top window (see table on page C-9).

Power Spectrum

The power spectrum (V^2) is the square of the magnitude spectrum. The power spectrum is displayed on the dBm scale, with 0 dBm corresponding to $V_{ref}^2 = (0.316 V_{peak})^2$, where V_{ref} is the peak value of the sinusoidal voltage which is equivalent to 1 mW into 50 Ω .

Power Density Spectrum

The power density spectrum (V^2/Hz) is the power spectrum divided by the equivalent noise bandwidth of the filter, in Hz.

The power density spectrum is displayed on the dBm scale, with 0 dBm corresponding to (V_{ref}^2/Hz) .

Sampling Frequency

The time-domain records are acquired at sampling frequencies which depend on the selected time base.

Before the FFT computation, the time-domain record may be decimated. If the selected maximum number of points is lower than the source number of points, the effective sampling frequency is reduced.

The effective sampling frequency equals twice the Nyquist frequency.

Scallop Loss

Loss associated with the picket fence effect (listed in the table on page C-9 for windows implemented).

Window Functions

All available window functions belong to the sum of cosines family with one to three non-zero cosine terms:

$$w_k = \sum_{m=0}^{M-1} a_m \cos \left(\frac{2\pi k}{N} m \right) \quad 0 \leq k < N$$

where $M = 3$ is the maximum number of terms

a_m are the coefficients of the terms

N is the number of points of the decimated source waveform

k is the time index

The table below lists the coefficients a_m .

The window functions, seen in the time domain are symmetric around the point $k = N/2$.

Window type	a0	a1	a2
Rectangular	1.0	0.0	0.0
von Hann	0.5	-0.5	0.0
Hamming	0.54	-0.46	0.0
Flat-Top	0.281	-0.521	0.198
Blackman-Harris	0.423	-0.497	0.079

COEFFICIENTS OF WINDOW FUNCTIONS

ERROR MESSAGES

For some combinations of source waveform properties and processing functions, one of the following error messages may be displayed at the top of the screen:

Incompatible input record type

FFT power average is defined only on a function defined as FFT.

Horizontal units don't match

FFT of a frequency-domain waveform is not available.

FFT source data zero filled

If there are invalid data points in the source waveform (at the beginning or at end of the record), these are replaced by zeros before FFT processing.

FFT source data over/underflow

The source waveform data has been clipped in amplitude, either in the acquisition (gain too high or inappropriate offset) or in previous processing. The resulting FFT contains harmonic components which would not be present in the unclipped waveform.

The settings defining the acquisition or processing should be changed to eliminate the over/underflow condition.

Circular computation

A function definition is circular (i.e. the function is its own source, indirectly via another function or expansion). One of the definitions should be changed.

REFERENCES

Bergland, G. D., "A Guided Tour of the Fast Fourier Transform", IEEE Spectrum, July 1969, pp. 41 – 52.

A general introduction to FFT theory and applications.

Harris, F. J., "On the Use of Windows for Harmonic Analysis with the Discrete Fourier Transform", Proceedings of the IEEE, vol 66, No 1, January 1978, pp. 51 – 83.

Classical paper on window functions and their figures of merit, with many examples of windows.

Brigham, E. O., "The Fast Fourier Transform", Prentice Hall, Inc., Englewood Cliffs, N. J., 1974.

Theory, applications and implementation of FFT. Includes discussion of FFT algorithms for N not a power of 2.

Ramirez, R. W., "The FFT Fundamentals and Concepts", Prentice Hall, Inc., Englewood Cliffs, N. J., 1985.

Practice oriented, many examples of applications.

Parameter measurements are based on the recommendations of IEEE Std 181-1977 "Standard on Pulse Measurement and Analysis by Objective Techniques", and terminology is derived from ANSI/IEEE Std 194-1977 "Standard Pulse Terms and Definitions".

VOLTAGE MEASUREMENTS In order to find magnitude reference crossings, the base and top magnitudes are assigned. The method employed follows IEEE Std 181-1977. The magnitude histogram of the waveform within the cursor window is created and searched for dominant magnitude populations. If no two dominant populations can be found, the minimum and the maximum of the distribution are used. Of the two magnitudes, the first in the cursor window is assigned to the Base line and the other to the Top line.

Amplitude is measured by the absolute difference between Base and Top.

Maximum determines the maximum voltage within the area defined by the cursors.

Minimum determines the minimum voltage within the area defined by the cursors.

The following can then be computed:

Peak to Peak value	=	Maximum - Minimum
Overshoot positive	=	(Maximum - higher value of Base and Top - Minimum) / Amplitude
Overshoot negative	=	(Maximum - lower value of Base and Top - Minimum) / Amplitude
Median	=	0.5 (Base + Top)

Note: In the following, v_i denotes the measured sample values. The number of data values used for computing Mean, Standard Deviation, RMS, and Area values depends on the identification of a periodic waveform. If one or more periods are identified, a sub-window is used which starts at the first mesial point (50% magnitude transition) and ends at the last mesial point on a leading edge in the original window (i.e. in the formulae below, N = the number of data points within the periods found up to a maximum of 100 periods). In all other cases, Mean, Standard Deviation, RMS, and Area are evaluated using all data points inside the cursor window.

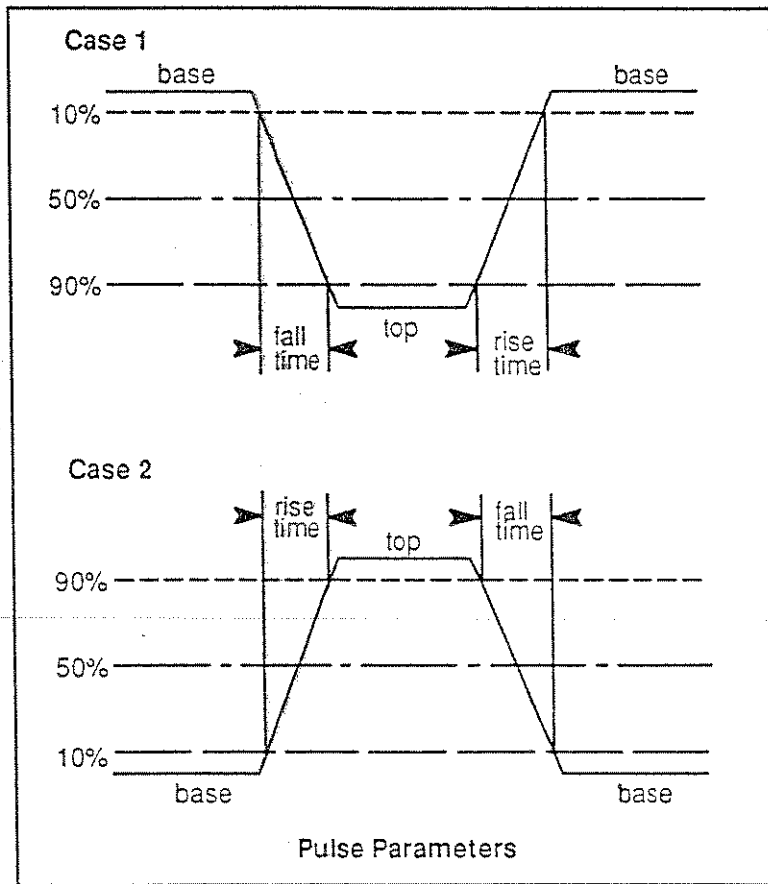

Mean determines the average value of all the data points selected as described above:

$$\frac{1}{N} \sum_{i=1}^N v_i$$

Standard Deviation (Sdev) is the standard deviation of the measured points from the mean. It is calculated from the following formula:

$$\sqrt{\frac{1}{N-1} \sum_{k=1}^N (v_i - \text{mean})^2}$$

RMS is derived from the square root of the average of the squares of the magnitudes, for all the data as described above.

$$\sqrt{\frac{1}{N} \sum_{k=1}^N (v_i)^2}$$

The Area covered by the signal is computed from the sum over all the data points selected, as described above, times the sample interval.

Time Measurements

Note: For the time measurements it is necessary to distinguish between magnitude crossings occurring on leading edges and those occurring on trailing edges. In the equations below the following notation has been used:

$M\uparrow$ = number of leading edges found

$M\downarrow$ = number of trailing edges found

t_i^x = time when leading edge i crosses the $x\%$ level

t_i^x = time when trailing edge i crosses the $x\%$ level

All times are linearly interpolated between two measured points.

Period is calculated from the average length of the full periods of the waveform within the selected interval. A full period is the time measured between the first and third 50% crossing points, the third and fifth, the fifth and seventh, etc.

$$\frac{1}{M\uparrow - 1} \sum_{i=1}^{M\uparrow - 1} (t_{i+1}^{50} - t_i^{50})$$

Frequency is then calculated as 1/Period.

Cycles gives the number of periods found.

Pulse Width (Width) determines the duration between the Pulse Start (mesial point, i.e. the 50% magnitude transition point, on the leading edge) and the Pulse Stop (mesial point on the trailing edge) of a pulse waveform. Like the pulse start, the pulse stop is a 50% magnitude reference point.

$$\frac{1}{M\downarrow} \sum_{i=1}^{M\downarrow} (t\uparrow_i^{50} - t\downarrow_i^{50})$$

Duty Cycle measures the Pulse Width as a percentage of the Pulse Period.

Risetime (Rise) measures the time of a pulse waveform's transition with a positive slope.

Falltime (Fall) measures the time of a pulse waveform's transition with a negative slope.

For both risetime and falltime measurements the instrument determines the duration between the proximal point (10% magnitude transition) and the distal point (90% magnitude transition) on leading edges and the duration between the distal point and the proximal point on trailing edges:

leading edge duration =

$$\frac{1}{M\uparrow} \sum_{i=1}^{M\uparrow} (t\uparrow_i^{90} - t\uparrow_i^{10})$$

trailing edge duration =

$$\frac{1}{M\downarrow} \sum_{i=1}^{M\downarrow} (t\downarrow_i^{10} - t\downarrow_i^{90})$$

Depending on the sign of the slope of the leading edge transition, the instrument then assigns either:

for positive slope: Risetime = leading edge duration
Falltime = trailing edge duration

for negative slope: Risetime = trailing edge duration
Falltime = leading edge duration

Delay is the time from the trigger point to the first 50% transition crossing, i.e. the **Pulse Start**.

$t_{t,50}$

- A**
- AC trigger coupling, 8-6
 - Accuracy DC, A-1
 - Acquisition
 - Modes, 8-1
 - Status menu, 24-1
 - Summary field, 7-1
 - Aliasing, 13-1
 - See also* WP02 – Fast Fourier Transform
 - Assistance, 2-1
 - AUTO button, 9-1
 - AUTO setup button, 9-2
 - Auto store, 20-1
 - Automatic
 - Calibration, 3-3
 - Mode, 9-1
 - Setup, 9-2
- B**
- Bandwidth limiter, 13-1
 - Batteries, 19-6, A-6
- C**
- Cabling for Printer/Plotter, 19-2
 - CAL BNC, 13-2, 19-1, A-6
 - Output, 19-15
 - Amplitude, 19-15
 - Frequency, 19-15
 - Pulse, 19-15
 - Square, 19-15
 - Trigger out, 19-15
 - Calibration, 13-2, A-6
 - Calibration, Automatic, 3-3
 - CKIO option, 10-4
 - Clear Sweeps button, 16-5, 16-8, 17-2, 22-9, 22-10
 - Coupling, 13-2
 - Coupling menu, 12-2, 12-4, 13-1
 - Cursors, 22-1, A-4
 - Menu, 22-6
 - Persistence display, 22-1
 - Standard display, 22-1
 - XY display, 22-1
 - Cursors/Measure Menu, 22-1
 - Custom parameters, 22-4, 22-11, 22-12
 - Customer Service, 2-1
- D**
- DC trigger coupling, 8-6
 - Delay knob, 9-3
 - Disk. *See* Floppy disk
 - Display
 - Layout, 7-1
 - Menu, 18-1
 - Persistence, 18-2
 - Size and resolution, A-3
 - Standard menu, 18-5
 - Standard mode, 18-3
 - Standard vs XY, 18-1
 - Trace field, 7-1
 - XY mode, 18-4
 - Dual grid, 18-5, 18-6
- E**
- ENBW – Equivalent Noise Bandwidth. *See* WP02 – Fast Fourier Transform
 - Enhanced Resolution, B-1
 - Setup Menu, 16-7
 - External clock, 10-4

F

FFT – Fast Fourier Transform. *See* WP02 –
Fast Fourier Transform

FIELDLOCK, 11–11

File transfers, 19–12, 19–13

Find button, 12–1, 12–3

FIR – finite impulse response filters, B–1

Floppy disk

Copying and formatting, 19–10

File transfers, 19–12, 19–13

Menu, 19–10

Panel recall, 23–2, 23–3

Panel save, 23–1

Structure, 19–8

Utilities, 19–1, 19–10

Waveform recall, 21–2

Waveform store, 20–1

Functions, Setup Menu, 16–12

Fuses, 4–1

G

GPIB

Menu, 19–5

Port selection, 19–5

GPIB/RS232 Setup menu, 19–1, 19–5

Grid, 7–3

Intensity, 18–5, 18–6

Selection, 18–5, 18–6

H

Hard copies, 17–2, 19–1, 19–2, 19–3, A–3

Hard options, 24–2

HF REJ trigger coupling, 8–6

HF trigger coupling, 8–6

Hold-off by time or number of events, 8–7,
11–2

Horizontal controls, 9–1

I

Intensity, 18–5, 18–6

Interleaved Sampling. *See* Timebase Setup
Menu

Internal printer setup menu, 19–3

L

Level knob, 9–3

LF REJ trigger coupling, 8–6

M

Maintenance, 2–2

Mask, 22–17, 22–18, 22–19

Math Setup, 15–2

Menu, 16–1

Memory Card

Copying and formatting, 19–7

File transfers, 19–12, 19–13

Menu, 19–7

Panel recall, 23–2, 23–3

Panel save, 23–1

Structure, 19–8

Utilities, 19–1, 19–7

Waveform recall, 21–2

Waveform store, 20–1

Menu

Field, 7–3

Use of, 6–1, 17–1

Message field, 7–3

Multi-zoom expansion, 14–1, 16–2

N

NORM button, 9–2
Nyquist frequency. *See* WP02 – Fast Fourier Transform

O

Offset, behaviour, 19–14
Offset knob, 12–1, 12–3

P

Panel Recall menu, 23–2, 23–3
Panel Setups, 17–2
Panel Setups menu, 23–1
Parameters
 See also Pulse parameters Menu, 22–8
Pass/Fail, 22–3, 22–13, 22–15, 22–16, 22–17, 22–20
Persistence Display, 18–2, 18–5, 18–6
 Cursors, 22–1
Picket fence effect. *See* WP02 – Fast Fourier Transform
Plotter. *See* Printer/plotter
Position
 Horizontal, 15–1, 16–2
 Vertical, 15–1, 15–2
Power average, C–2
Power density, 16–10, C–1
Power requirements, 4–1
Power spectrum, 16–10, C–1
 See also WP02 – Fast Fourier Transform
Printer/Plotter, Cabling, 19–2
Printer/plotter, Setup menu, 19–1

Probes, 13–2, A–6
 Attenuation, 13–1
 Calibrator, 13–2, A–6
Pulse parameters, 22–3, 22–4
 Custom parameters, 22–11, 22–12
 Information and warning symbols, 22–5
 Time measurements, 22–10, D–3
 Voltage measurements, 22–9, D–1

Q

Quad grid, 18–5, 18–6

R

RAN – Return Authorization Number, 2–2
Random Interleaved Sampling, 8–2
Real-time clock field, 7–1
Recalling front-panel setups, 23–2, 23–3
Recalling waveforms, 14–2, 21–1, 21–2
Remote Control, 3–3
 Specifications, A–6
Remote control and interruption, 6–1
Rescale. *See* WP01
Reset
 General instrument, 6–3, 17–3
 Position/Zoom, 14–3, 15–2
Return button, 6–1
Return Procedure, 2–2
RIS – Random Interleaved Sampling, 8–2
 Timebase setup menu, 10–1
Roll Mode, 8–3
RS232
 Cabling, 19–2
 Connector, 19–6
 Menu, 19–5
 Port selection, 19–5

INDEX

S

Safety Information, 4-1
Sampling frequency, 10-1
Saving front-panel setups, 23-1
Screen Dump
 Button, 17-2
 Hardcopy setup, 19-2
Screen dump, Printer/plotter setup, 19-1
Select
 ABCD, 15-1
 Channel, 12-3
Sensitivity (Volts/div), 12-1, 12-4, A-1
Sequence Mode, 8-3, 16-2, 19-14, 24-3
Serial number, 24-2
Service Procedure, 2-2
Show Status button, 24-1
Single-shot acquisitions, 8-1
SMART trigger. *See* Trigger
SNGL button, 9-2
Soft options, 24-2
Soft version, 24-2
Special Modes, 19-1
 AUTO sequence time-out, 9-1
 Menu, 19-14
 Offset behavior on gain change, 12-1,
 12-4
Specifications, A-1
 Bandwidth, A-1
 General, A-6
 Horizontal, A-2
 Measurements, A-4
 Processing, A-4
 Remote control, A-6

 Trigger, A-2, A-3
 Vertical, A-1
Standard display mode, 18-3
STOP button, 9-1
Store
 Panel Setup, 23-1
 Waveform. *See* Waveform Store
Sweeps
 Averaging, 16-5, 16-6
 Extrema, 16-8, 16-9
 FFT Power Average, 16-11
 Pass/Fail, 22-13
 Statistics, 22-8
System summary, 24-2

T

Text & times summary, 24-3
Time and Frequency field, 7-2
Time/Date Setup menu, 19-1, 19-4
Time/div knob, 9-3
Timebase Setup
 External clock, 10-4
 Menu, 9-3, 10-1
 Record length, 10-1, 10-3
 RIS, 10-1
 Sampling, 10-1
 Sequence, 10-1, 10-2
 Time/Div, 9-3
Trace
 Channels, 12-1, 12-3
 On/Off, 15-1
 On/Off buttons, 12-1, 12-3
 Select, 12-3, 15-1
Trigger, 3-2
 Configuration field, 7-2
 Delay field, 7-2

- Edge, 8-5, 11-2
 - Coupling, 8-6, 11-2
 - Holdoff, 8-7, 11-2
 - Level, 8-7
 - Line, 8-5, 11-2
 - Slope, 8-6, 11-2
 - Source, 8-5, 11-2
 - Window, 8-6, 11-2
 - Level field, 7-1
 - Level Indicator fields, 7-2
 - SMART, 8-5
 - Dropout, 11-16, 11-17
 - Edge-qualified, 11-14, 11-15
 - GLITCH, 11-5, 11-6
 - Interval, 11-7, 11-8
 - Menu, 11-1
 - State-qualified, 11-12, 11-13
 - TV, 11-9, 11-10, 11-11
 - Width-based triggering, 11-5, 11-6, 11-7, 11-8
 - Status field, 7-2
 - Symbols, 11-3, 11-18
 - Trigger Setup, Menu, 9-3, 11-1
 - Trigger time stamps, 8-4, 24-3
 - TV trigger, 11-9, 11-10, 11-11
 - Characteristics, 11-11
 - FIELDLOCK, 11-11
- U**
- Utilities
 - Floppy disk menu, 19-10
 - GPIB menu, 19-5
 - Hardcopy setup menu, 19-2
 - Internal printer setup menu, 19-3
 - Main menu, 19-1
 - Memory Card menu, 19-7
 - RS232 menu, 19-5
 - Special Modes menu, 19-14
 - Time/Date menu, 19-4
- V**
- VAR button, 12-1, 12-4
 - Vertical Controls, 12-1, 12-3
 - Voltage, operating, 4-1
 - Volts/div knob, 12-1, 12-4
- W**
- Warranty, 2-1
 - Waveform Processing, 14-2, 14-3, 16-1, A-4
 - Arithmetic (+, -, *, /), 16-4
 - Averaging, summed, 16-5, 16-6
 - Functions (Negation, Identity), 16-12, 16-13
 - Maximum number of points, 14-3, 16-2
 - Waveform Recall Menu, 21-1, 21-2
 - Waveform Store menu, 20-1
 - Waveform summary, 24-4
 - Window trigger, 8-6, 11-2
 - Windows. See WP02 - Fast Fourier Transform
 - WP01
 - Arithmetic (+, -, *, /), 16-4
 - Continuous averaging, 16-5, 16-6
 - Enhanced resolution, 16-7, B-1
 - Extrema, 16-8, 16-9
 - Functions, 16-12, 16-13
 - Rescale, 16-14
 - Summed averaging, 16-5, 16-6
 - WP02 - Fast Fourier Transform
 - Algorithms, C-3
 - Aliasing, C-9
 - Cursors, C-3
 - ENBW - Equivalent Noise Bandwidth, C-9
 - Examples, C-7
 - Glossary, C-9
 - Power average, C-2, C-6
 - Setup menu, 16-10

INDEX

Setup menu for power average, 16-11
Windows, 16-10, C-2, C-7, C-9, C-12

X

XY Display, 18-1, 18-4
Cursors, 22-1
Menu, 18-6
Reference point, 22-6

Z

Zero button, 9-3
Zoom, 14-1, 14-3, 15-1
Horizontal, 15-1, 16-2
Menu, 16-2
Multi, 14-1, 16-2
Setup Menu, 16-3
Vertical, 15-1, 15-2

ADDRESSES

US SALES OFFICES

1 800-5-LeCroy (automatically connects you to your local sales office)

WORLDWIDE

Argentina: Search SA, (01) 46 6156
Australia: Scientific Devices Pty.Ltd,
(03) 579-3622
Austria: Dewetron GmbH, (0316) 391804
Benelux: LeCroy B.V., 4902 8 9285
Brazil: ATP-Hi-Tek, (011) 725.5822
Canada: LeCroy Canada Inc, (514) 928-4707
Chile: Sistemas de Instrumentacion
(562) 695.1137
Denmark: Lutronic, (42) 459764
Eastern Europe: Elsinco GmbH, Vienna
222 812 1751
Finland: Orbis OY, (90) 566.4066
France: LeCroy Sarl (16)907 3897
Germany: LeCroy GmbH, (06221) 831001
(North) (0405) 42713
Greece: Hellenic S/R Ltd., (01) 721 1140
Hong Kong: Euro Tech (Far East) Ltd.
8.52.814.0311
India: TATA-Honeywell, (212) 670.445
Indonesia: P.T. DWI, (6221) 570.4563
Israel: Ammo, (03) 453157
Italy: LeCroy S.r.l., Roma (06) 336.797.00
Milano (02) 204 7082
(02) 2940-5634
Japan: LeCroy Japan,
Tokyo (0081) 3 376 9400
Osaka (0081) 6 330 0961

Korea: Woojoo Hi-Tech Corp.
(02) 82.2.449.5472
Mexico: Nucleoelectronica SA:
(905) 593 6043
New Zealand: E.C. Gough Ltd.,
(03) 379.8740
Norway: Avantec AS, (02) 630520
Pakistan: Electro Tech Corp.Ltd.,
(021) 493 8087
Portugal: M.T. Brandao, Lda., (02) 815680
Singapore: Singapore Elec. & Eng. Ltd.,
(065) 283.6288
S. Africa: Westplex, (011)787 0473
Spain: Essa, (01)359 0088
Sweden: MSS AB, (0764) 68100
Switzerland: LeCroy S.A., (022) 719 2111
Taiwan: Topward El. Inst., Ltd.,
(02) 601 8801
Thailand: Measuretronix Ltd.,
(02) 3752733-4
United Kingdom: LeCroy Ltd., (23) 553 3114

LeCROY CORPORATE HEADQUARTERS

700 Chestnut Ridge Road
Chestnut Ridge, NY 10977-6499
Telephone: (914) 425-2000
TWX:(710) 577-2832
Fax: (914) 425-8967

LeCROY EUROPEAN HEADQUARTERS

2, rue du Pré-de-la-Fontaine
P.O. Box 341
1217 Meyrin 1/Geneva, Switzerland
Tel.: (022) 719 21 11 Telex: 419 058
Fax: (022) 782 39 15

